

CATÁLOGO

GERAL DE PERFIS

H **eledial**
ALUMÍNIO

2026



eledial
ALUMÍNIO

SEÇÃO	PÁGINA
PERFIS TABELADOS	05 - 07
CONTRAMARCOS	08 - 08
VENEZIANAS	09 - 09
CONEXÕES	10 - 11
ARREMATES	12 - 12
LINHA 25	13 - 19
LINHA 30	20 - 24
LINHA 42	25 - 25
LINHA TMS	26 - 41
LINHA INTEGRADA	42 - 42
BOX LISO	43 - 44
BOX VIDRO 8 MM	45 - 47
BOX VIDRO 10 MM	48 - 49
BOX VIDRO 8/10 MM	50 - 50
BOX VIDRO DIVERSOS	51 - 51
PORTÕES E GRADES	52 - 53
PORTÕES	54 - 56
TELA MOSQUITEIRO	57 - 58
LAMBRIS	59 - 60
COLUNA E TAMPAS	61 - 61
VITRINES	62 - 62
VITRINES E REVESTIMENTOS	63 - 63
GUARDA-CORPO	64 - 67
DIVERSOS	68 - 68

Código	Peso	Página
29-160	1,428	55
39-081	0,772	67
39-811	3,070	56
78-054	1,051	68
A-022	0,317	45
A-041	0,640	22
A-055	0,463	17
A-056	0,374	17
A-058	0,201	58
A-072	1,203	62
A-144	0,824	23
A-194	0,572	18
A-195	0,627	18
AB-129	0,252	13
BAR-4037	0,382	12
CG-083	1,410	68
CL-006	0,997	11
CL-011	0,317	11
CM-060	0,241	9
CM-063	0,203	9
D-055	0,504	66
D-069	0,900	54
D-078	0,653	55
D-079	0,523	53
D-081	0,572	65
D-082	0,320	66
D-095	0,413	65
D-102	0,547	53
D-103	0,770	53
DP-001	0,141	47
DP-011	0,547	52
E-117	0,325	44
E-150	0,268	25
E-168	0,222	64
E-277	0,447	14

Código	Peso	Página
E-306	0,428	49
E-363	1,051	57
E-364	0,472	57
E-365	0,653	57
E-512A	0,380	49
I-083	0,339	45
I-105	0,230	14
L-468	1,577	12
L-519	0,274	24
L-592	0,282	20
L-713A	0,957	49
L-715	0,279	41
M-027	0,596	57
ME-013	0,266	13
MP-347	0,184	13
P-064	0,383	24
P-068	0,555	21
P-075	0,550	21
P-078	0,683	21
P-084	0,528	21
P-120	0,531	24
P-121	0,504	24
P-140	0,436	15
P-145	0,434	19
P-146	0,401	19
P-147	0,325	19
P-153	0,532	15
P-155	0,542	17
P-166	0,376	20
P-167	0,377	20
P-227	0,463	58
P-256	0,520	58
P-264	1,092	23
P-270	0,780	23
P-273	0,612	23

Código	Peso	Página
P-318	0,575	16
P-319	0,721	16
P-358	0,908	22
P-412	0,537	18
TMB-081A	0,130	47
TMB-096	0,626	65
TMB-102	0,152	48
TMB-115	0,233	48
TMB-116	0,263	46
TMN-007	0,715	43
TMN-055	0,380	43
TMR-1035	1,436	52
TMR-1190	0,190	58
TMR-1381	0,807	61
TMR-1447	0,252	69
TMR-3093	0,984	61
TMR-624	0,840	66
TMR-625	0,282	66
TMR-626	0,520	66
TMR-714	0,328	48
TMR-716	0,084	48
TMR-719	0,163	51
TMR-720	0,235	51
TMR-742	0,315	59
TMR-743	0,405	59
TMR-790	0,157	50
TMR-792	0,057	46
TMR-793	0,141	46
TMR-821	0,162	47
TMR-835	0,320	63
TMR-837	0,195	63
TMR-845	0,585	46
TMS-001	0,740	27
TMS-002	0,493	27
TMS-003	0,493	27

Código	Peso	Página
TMS-004	0,520	28
TMS-005	1,058	28
TMS-007	0,386	29
TMS-008	0,247	29
TMS-009	0,893	29
TMS-010	0,989	31
TMS-011	0,940	31
TMS-012	0,542	31
TMS-013	0,742	32
TMS-014	0,647	32
TMS-017	0,233	29
TMS-039	0,488	34
TMS-040	0,476	34
TMS-041	0,485	34
TMS-042	0,561	35
TMS-050	0,930	35
TMS-053	0,471	34
TMS-068	0,495	38
TMS-069	0,577	38
TMS-070	0,517	38
TMS-079	0,333	40
TMS-080	0,360	39
TMS-081	0,404	39
TMS-082	0,382	39
TMS-083	0,146	39
TMS-084	0,114	39
TMS-086	0,596	40
TMS-096	0,306	40
TMS-097	0,404	40
TMS-098	0,404	40
TMS-102	0,111	42
TMS-103	0,141	42
TMS-108	0,142	42
TMS-110	0,534	41
TMS-111	0,615	41

Código	Peso	Página
TMS-120	0,466	41
TMS-121	1,449	33
TMS-122	1,401	33
TMS-123	0,970	33
TMS-187	0,509	38
TMS-191	0,542	38
TMS-192	0,517	34
TMS-200	0,442	39
TMS-203	0,130	42
TMS-225	0,997	35
TMS-227	0,556	35
TMS-228	0,669	30
TMS-230	0,940	32
TMS-242	0,710	36
TMS-243	0,710	36
TMS-244	0,661	36
TMS-245	0,672	36
TMS-246	0,593	36
TMS-260	0,609	30
TMS-279	0,552	41
TMS-289	1,225	37
TMS-290	1,255	37
U-1092	0,442	67
U-1098	0,569	54
U-1108	0,358	52
U-396	0,239	45
U-397	0,680	44
U-398	0,249	45
U-399	0,239	44
U-425	0,154	14
U-482	0,114	25
U-491	0,095	49
U-509	0,192	50
U-522	0,092	15
U-555	0,271	50

Código	Peso	Página
U-615	0,368	62
U-621	0,265	62

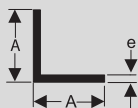

CANTONEIRAS DE ABAS IGUAIS

Código Alcan / Outros	Código Tamboré	Milímetros			Polegadas		Peso Kg/m
		A	e	A	e		
L-002	L-002	12,70	1,58	1/2	1/16	0,100	
L-405	L-405	15,87	1,60	5/8	1/16	0,127	
L-009	L-009	19,05	1,60	3/4	1/16	0,157	
L-013	L-013	25,40	1,58	1	1/16	0,211	
L-014	L-014	25,40	3,18	1	1/8	0,409	
L-018	L-018	31,75	3,18	1 1/4	1/8	0,520	
L-744	L-744	38,10	1,57	1 1/2	1/16	0,322	
L-022	L-022	38,10	3,20	1 1/2	1/8	0,634	
L-612	L-612	50,80	2,00	2	-	0,539	
L-025	L-025	50,8	3,18	2	1/8	0,848	

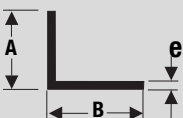

CANTONEIRAS DE ABAS DESIGUAIS

Código Alcan / Outros	Código Tamboré	Milímetros			Polegadas			Peso Kg/m
		A	B	e	A	B	e	
L-100	L-100	38,10	25,40	3,20	1 1/2	1	1/8	0,523
L-104	L-104	50,80	25,40	3,18	2	1	1/8	0,629
-	TMR-1113	94,3	30	1,6	-	-	-	0,531

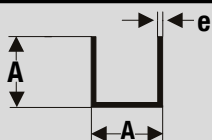

PERFIL U DE ABAS IGUAIS

Código Alcan / Outros	Código Tamboré	Milímetros		Polegadas		Peso Kg/m
		A	e	A	e	
U-036	U-036	9,52	1,60	3/8	1/16	0,108
U-044	U-044-A	12,70	1,10	1/2	-	0,107
U-509	U-509-A	15,87	1,30	5/8	-	0,157

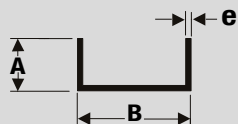

PERFIL U DE ABAS DESIGUAIS

Código Alcan / Outros	Código Tamboré	Milímetros			Polegadas			Peso Kg/m
		A	B	e	A	B	e	
U-037	U-037	12,70	9,52	1,60	1/2	3/8	1/16	0,129
U-055	U-055	12,70	19,05	1,00	1/2	3/4	-	0,114
-	TMR-765	24,80	11,20	1,00	-	-	-	0,160
U-555	U-555-L	25,40	15,87	1,4	1	5/8	-	0,24

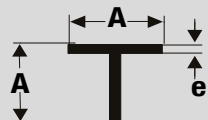

PERFIL T

Código Alcan / Outros	Código Tamboré	A mm	B mm	A Pol.	B Pol.	Peso Kg/m
T-076	T-076	25,40	1,60	1,00	1/6	0,214



BARRA RETANGULAR

Código Alcan / Outros	Código Tamboré	Milímetros		Polegadas		Peso Kg/m
		B	e	Largura	e	
BAR-012	BAR-012	12,70	3,18	1/2	1/8	0,108
BAR-049	BAR-049	15,87	4,76	5/8	3/16	0,206
BAR-014	BAR-014	19,05	3,18	3/4	1/8	0,162
BAR-016	BAR-016	25,40	3,18	1	1/8	0,219
BAR-019	BAR-019	31,75	3,18	1 1/4	1/8	0,274
BAR-022	BAR-022	38,10	3,18	1 1/2	1/8	0,328
BAR-027	BAR-027	50,8	3,17	2	0,125	0,436

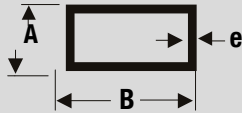

TUBO RETANGULAR

Código Alcan / Outros	Código Tamboré	Milímetros			Polegadas			Peso Kg/m
		B	A	e	B	A	e	
-	TMR-410	25,40	12,70	1,00	1	1/2	-	0,198
TUB-4536	TUB-4536L	50,80	12,70	1,30	2	1/2	-	0,428
TUB-4576	TUB-4576	50,80	25,40	1,00	2	1	-	0,401
TUB-4517	TUB-4517	76,20	38,10	2,00	3	1 1/2	-	1,195
-	TUB-4599-A	101,60	50,80	1,69	4	2	-	1,36

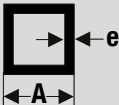

TUBO QUADRADO

Código Alcan / Outros	Código Tamboré	Milímetros		Polegadas		Peso Kg/m
		A	e	A	e	
TUB-4001	TUB-4001-L	12,70	1,30	1/2	-	0,160
TUB-4002	TUB-4002	15,87	1,50	5/8	-	0,233
-	TMR-468	19,05	1,20	3/4	-	0,233
-	TUB-4008-L	25,40	1,30	1	-	0,340
TUB-4011	TUB-4011	31,75	1,50	1 1/4	-	0,493
TUB-4014	TUB-4014	38,10	1,50	1 1/2	-	0,596
-	TUB-4020-A	50,80	1,30	2	-	0,705
TUB-4054 L	TUB-4054 L	101,60	1,58	4	1/16	1,72



TUBO REDONDO

Código Alcan / Outros	Código Tamboré	Milímetros		Polegadas		Peso Kg/m
		A	e	A	e	
TUB-003	TUB-003L	9,53	1,20	3/8	-	0,084
-	TUB-009L	12,70	1,10	1/2	-	0,108
TUB-018	TUB-018	15,87	1,24	5/8	-	0,152
TUB-027	TUB-027	19,05	1,24	3/4	-	0,187
TUB-037	TUB-037	22,22	1,24	7/8	-	0,222
TUB-044	TUB-044	25,40	1,00	1	-	0,206
TUB-461	TUB-461	31,75	1,00	1 1/4	-	0,263
TUB-069	TUB-069	38,10	1,50	1 1/2	-	0,466
TUB-610	TUB-610	50,80	1,50	2	1/16	0,631

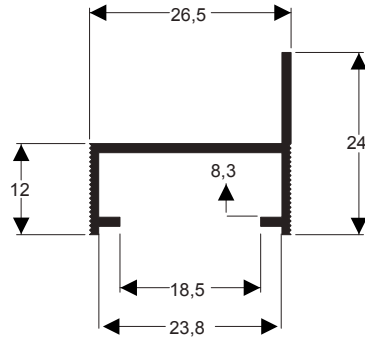

CM-063
0,203 kg/m

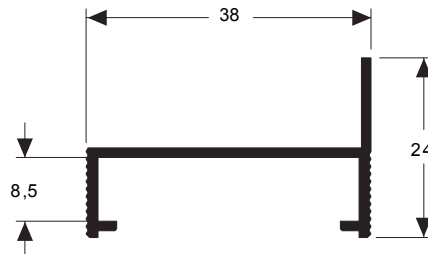

CM-060
0,241 kg/m

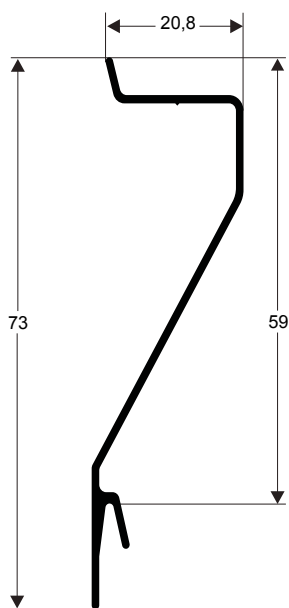

Z-203P
0,322 kg/m

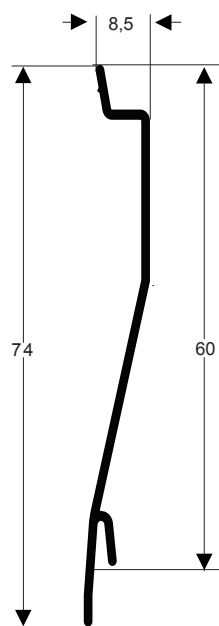

Z-201P
0,263 kg/m

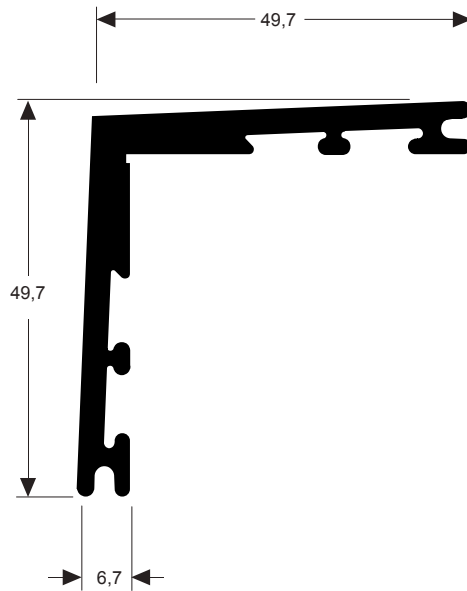

CL-006
0,997 kg/m

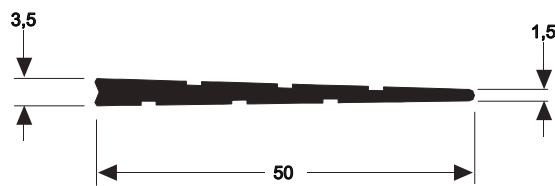

CL-011
0,317 kg/m

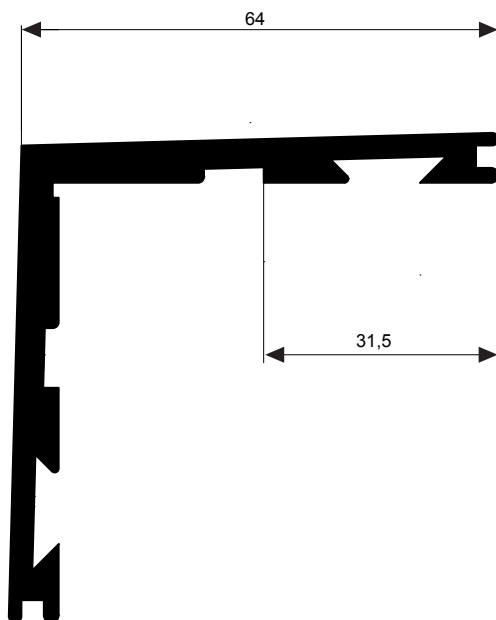

L-468

1,577 kg/m

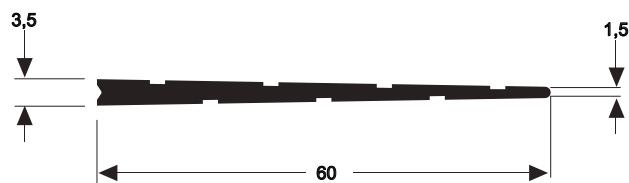

BAR-4037

0,382 kg/m

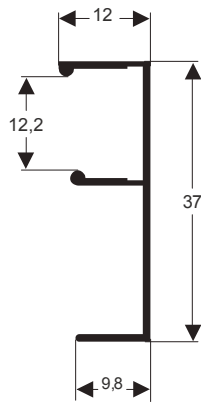

MP-347
0,184 kg/m

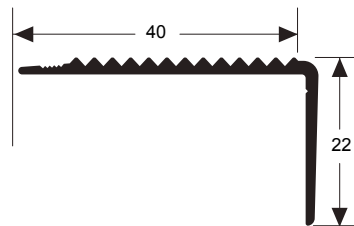

AB-129
0,252 kg/m

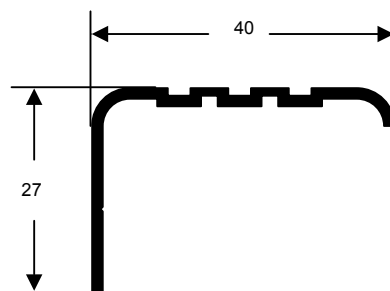

ME-013
0,266 kg/m

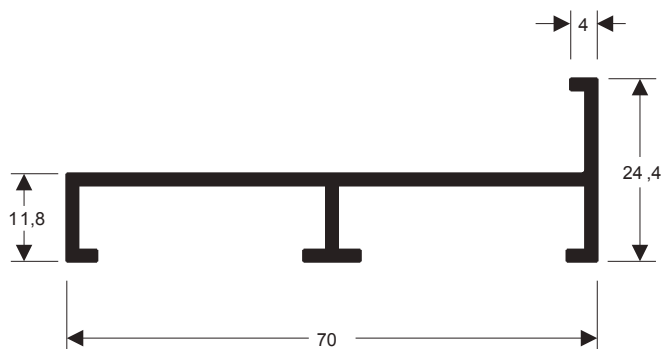

E-277
0,447 kg/m

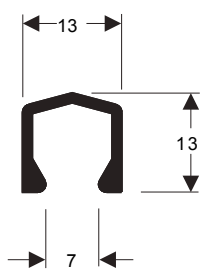

U-681
0,117 kg/m

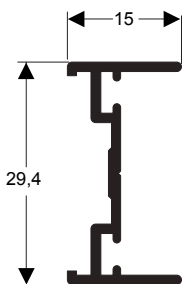

I-105
0,230 kg/m

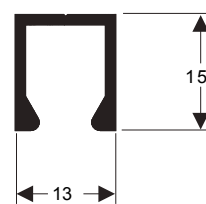

U-425
0,154 kg/m

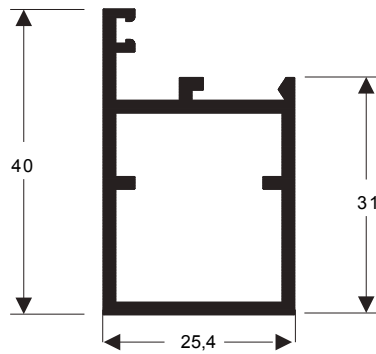

P-140
0,436 kg/m

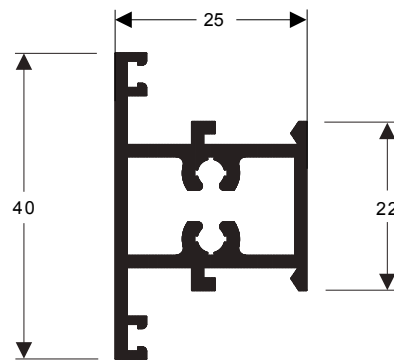

P-153
0,532 kg/m

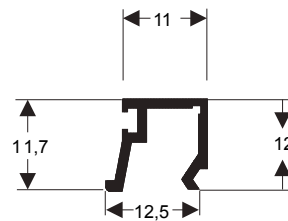

U-522
0,092 kg/m

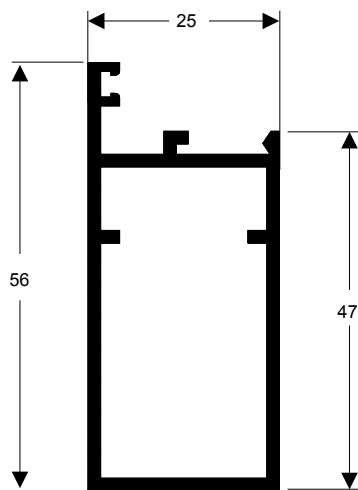

P-318

0,575 kg/m

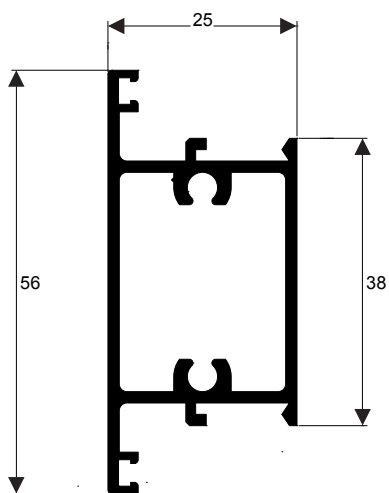

P-319

0,721 kg/m

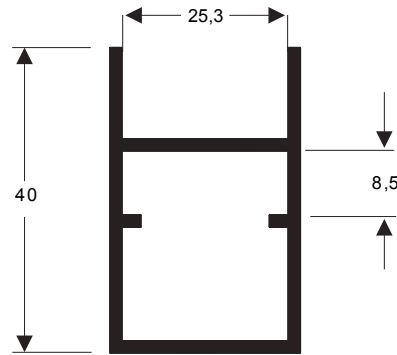

A-055

0,463 kg/m

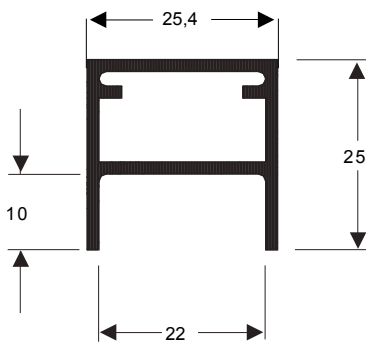

A-056

0,374 kg/m

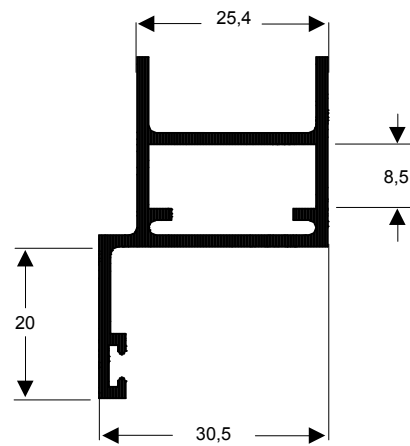

P-155

0,542 kg/m

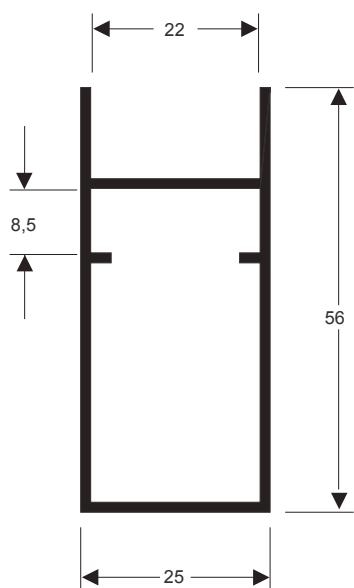

A-194
0,572 kg/m

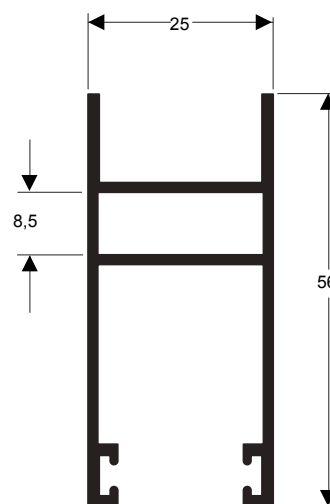

A-195
0,627 kg/m

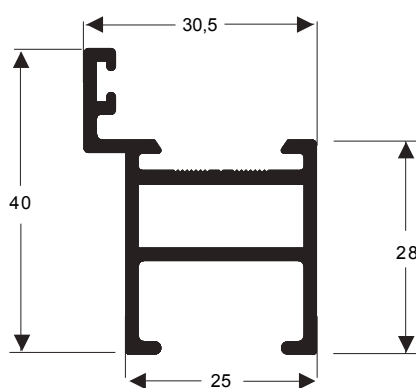

P-412
0,537 kg/m

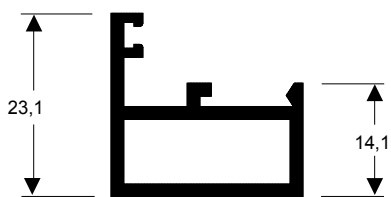

P-147
0,325 kg/m

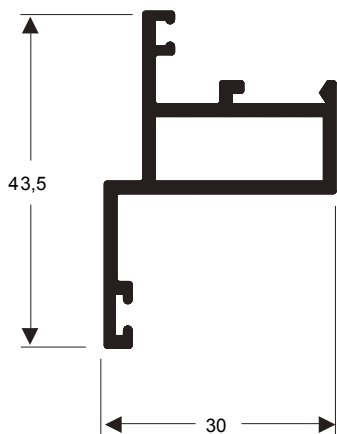

P-146
0,401 kg/m

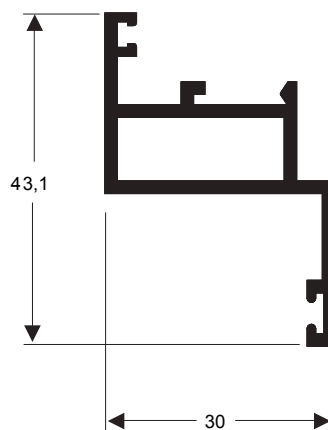

P-145
0,434 kg/m

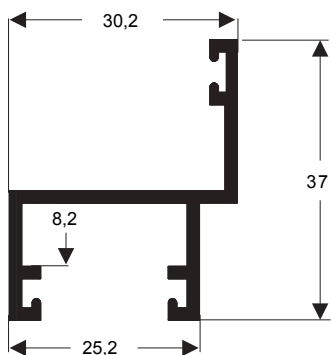

Y-126
0,347 kg/m

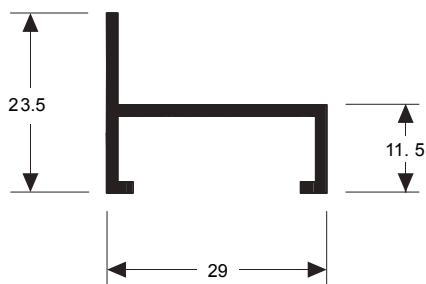

Y-120
0,222 kg/m

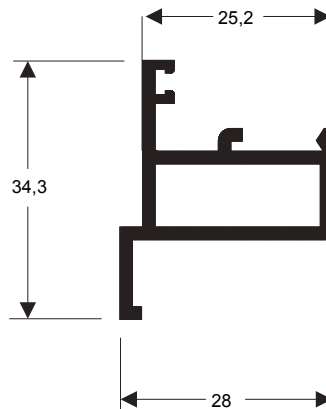

P-167
0,377 kg/m

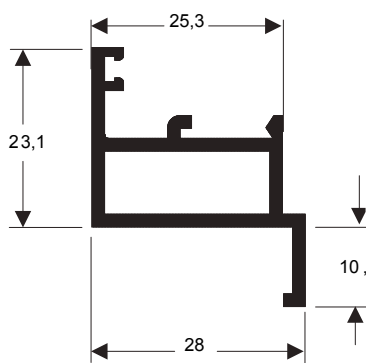

P-166
0,376 kg/m

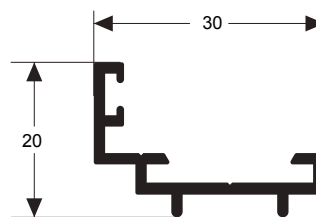

L-592
0,282 kg/m

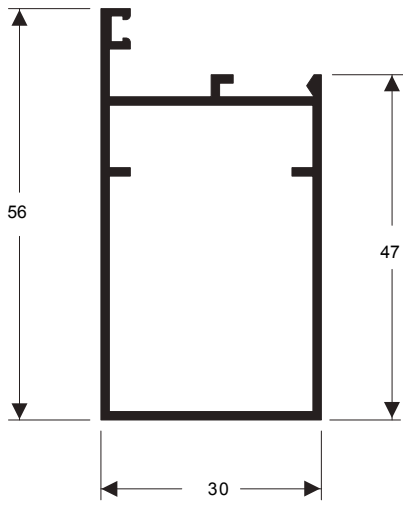

P-068
0,555 kg/m

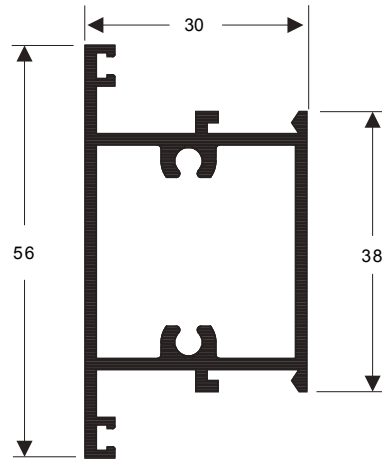

P-078
0,683 kg/m

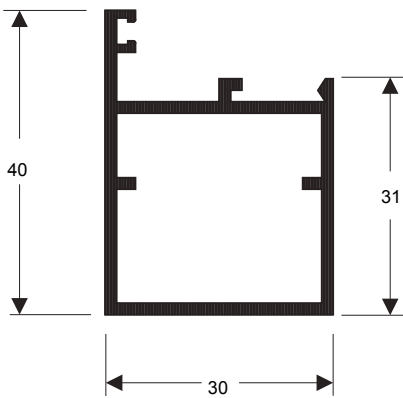

P-084
0,528 kg/m

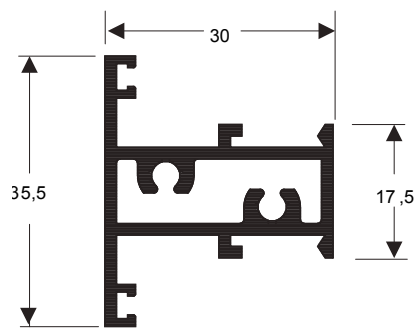

P-075
0,550 kg/m

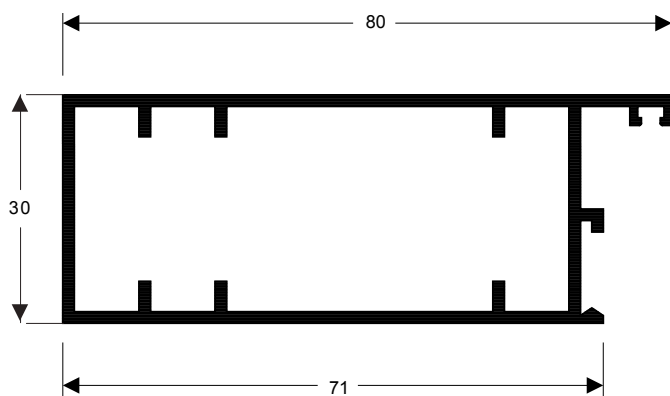

P-358

0,908 kg/m

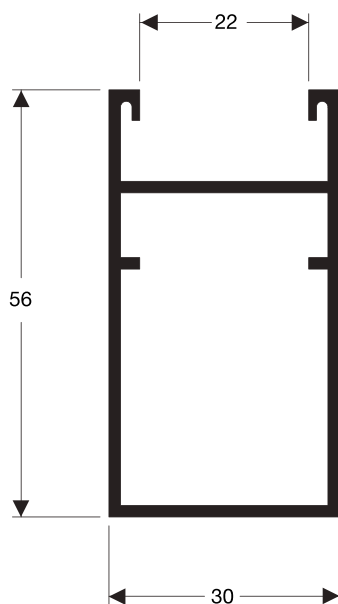

A-041

0,640 kg/m

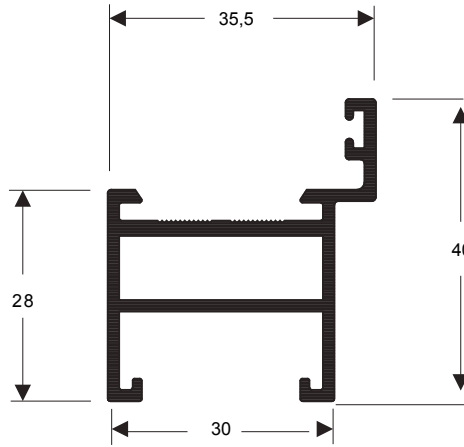

P-273

0,612 kg/m

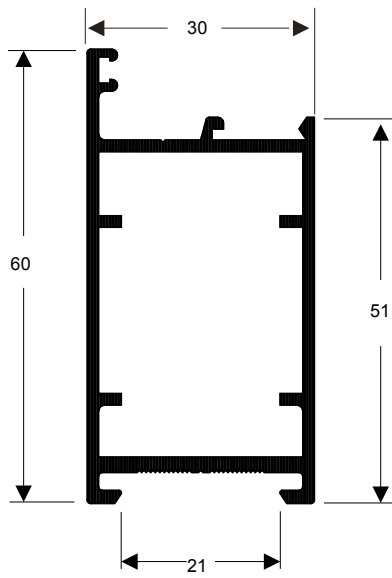

P-270

0,780 kg/m

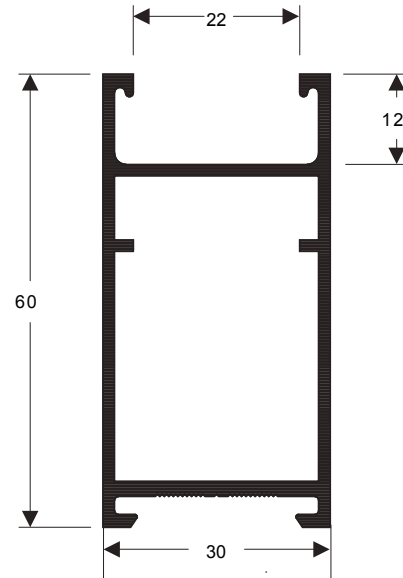

A-144

0,824 kg/m

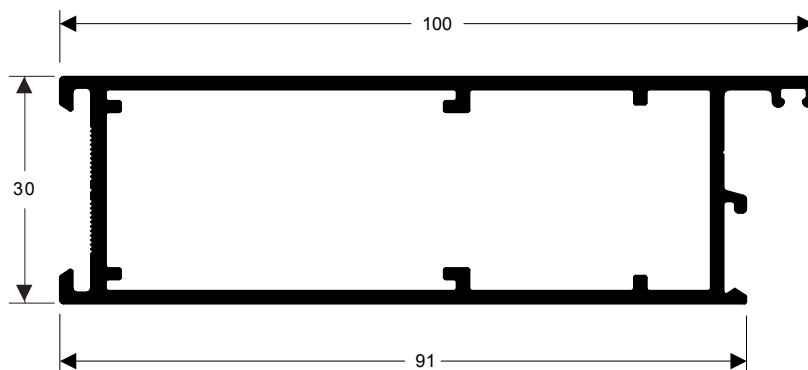

P-264

1,092 kg/m

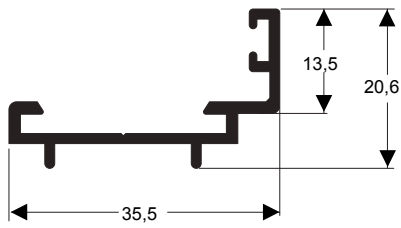

L-519
0,274 kg/m

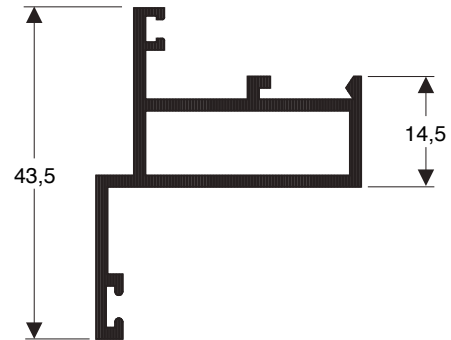

P-120
0,531 kg/m

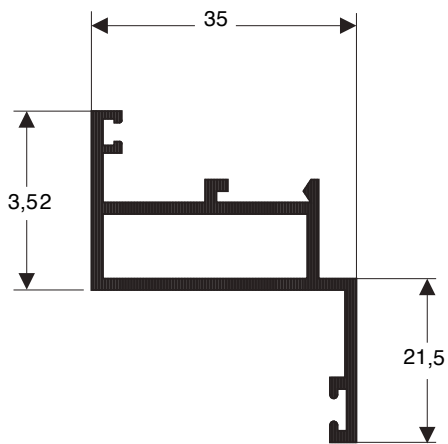

P-121
0,504 kg/m

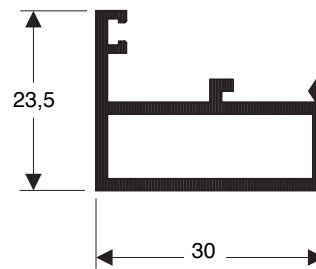

P-064
0,383 kg/m

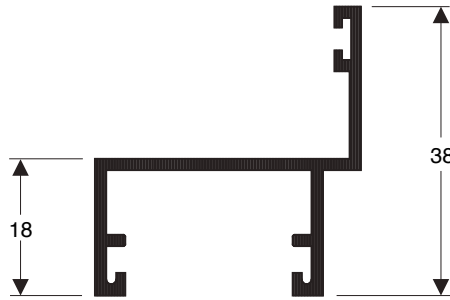

Y-140

0,398 kg/m

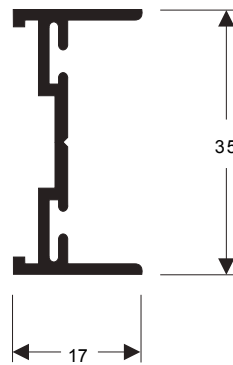

E-150

0,268 kg/m

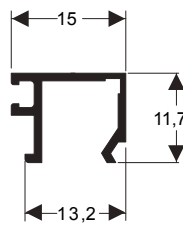

U-482

0,114 kg/m

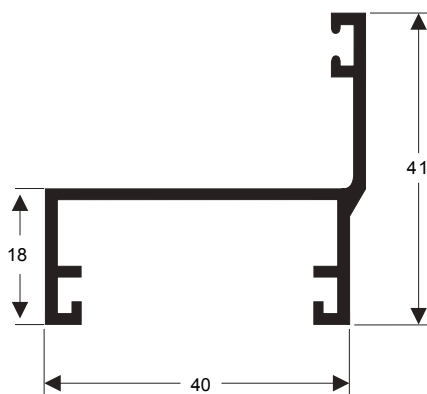

Y-181

0,469 kg/m

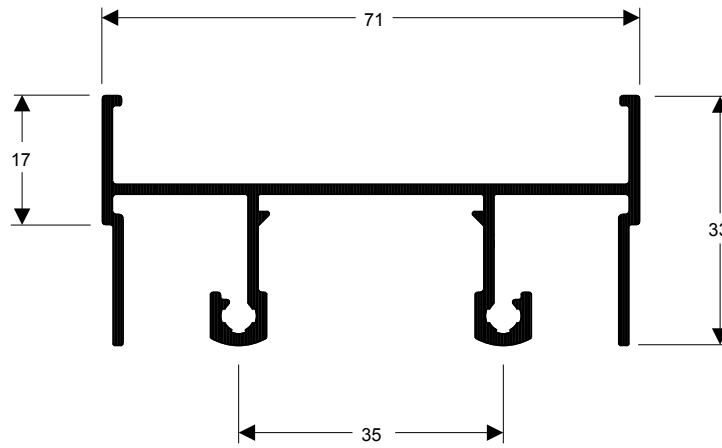

TMS-001
0,740 kg/m

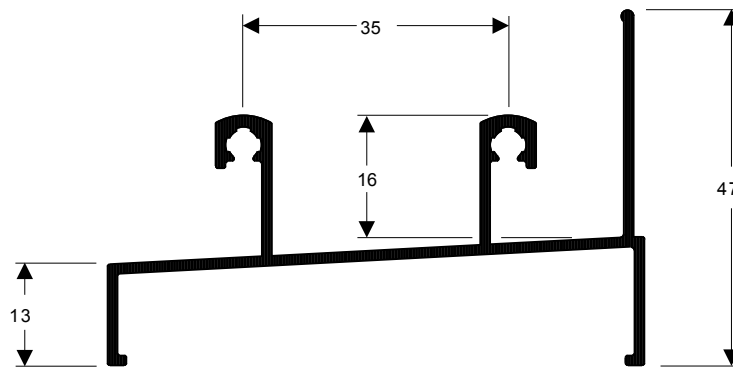

TMS-002
0,493 kg/m

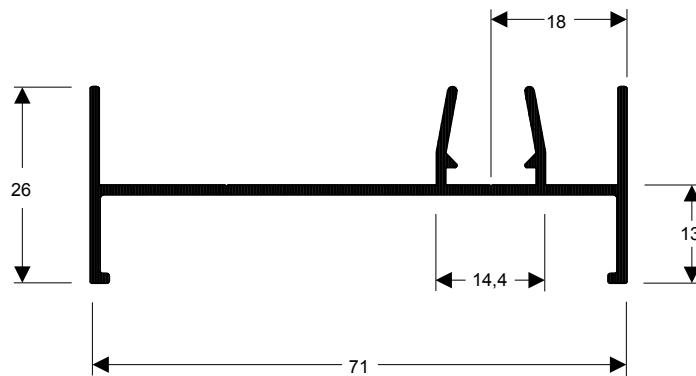

TMS-003
0,493 kg/m

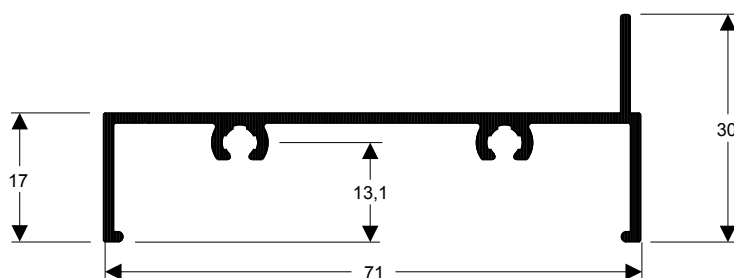

TMS-004
0,520 kg/m

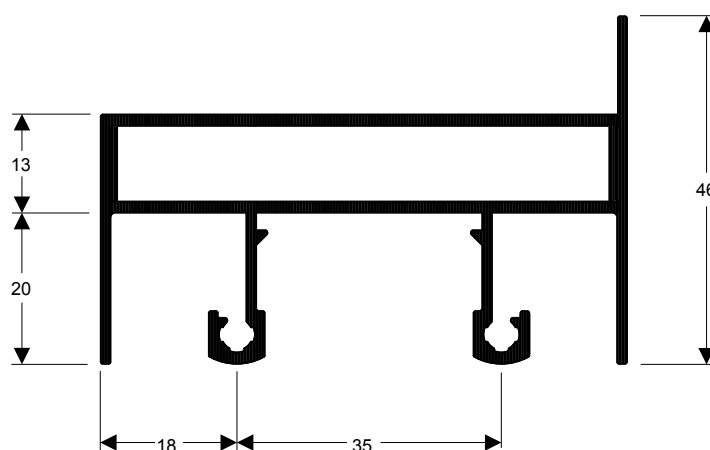

TMS-005
1,058 kg/m

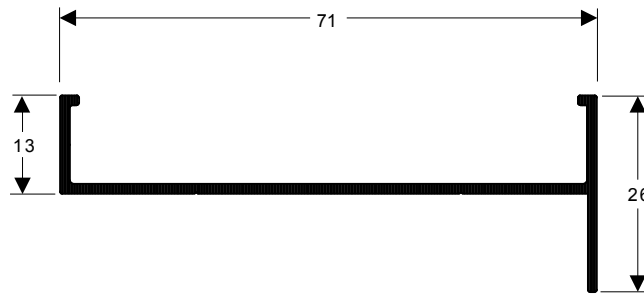

TMS-007
0,386 kg/m

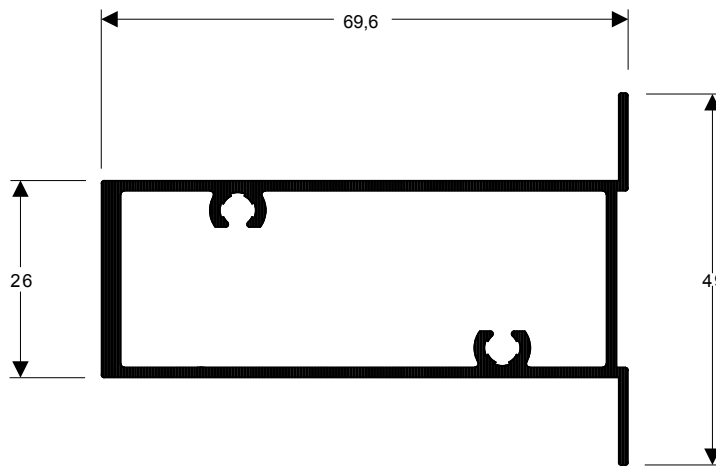

TMS-009
0,893 kg/m

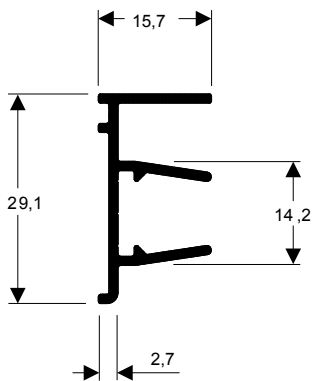

TMS-008
0,247 kg/m

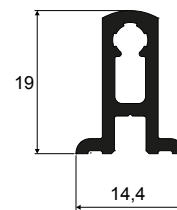

TMS-017
0,233 kg/m

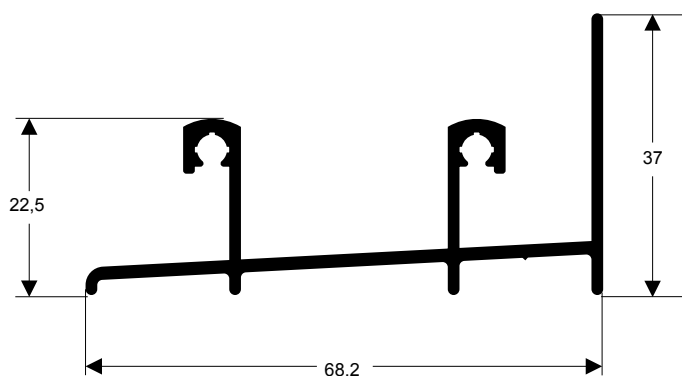

TMS-228
0,669 kg/m

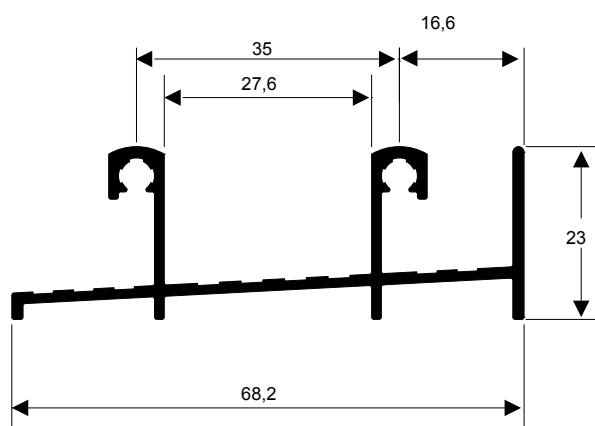

TMS-260
0,609 kg/m

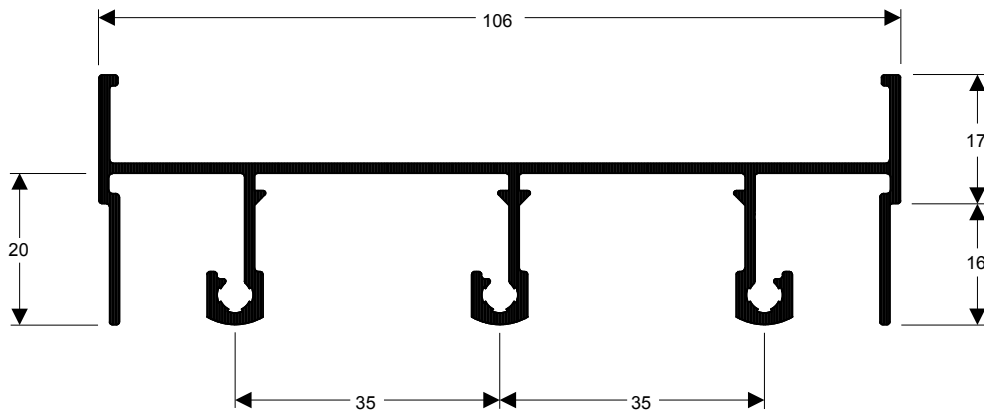

TMS-010
0,989 kg/m

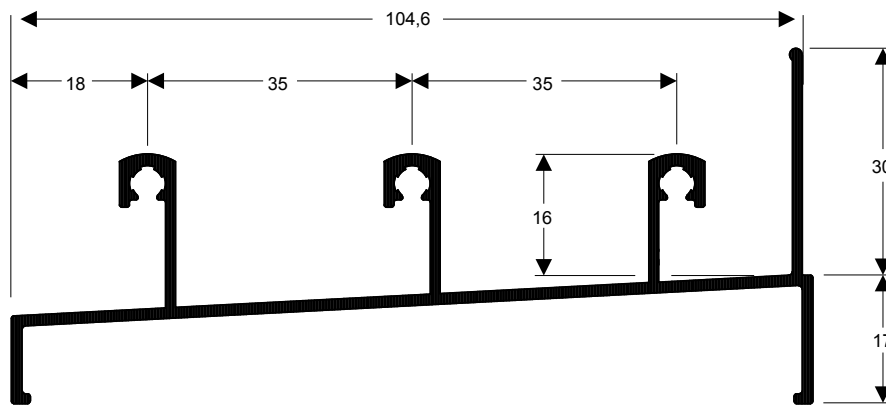

TMS-011
0,940 kg/m

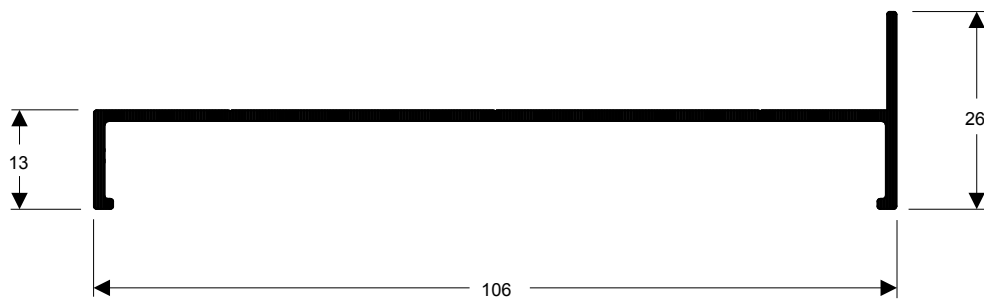

TMS-012
0,542 kg/m

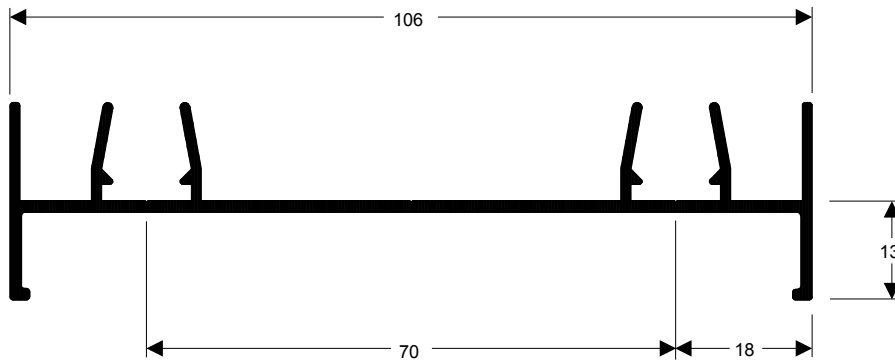

TMS-013
0,742 kg/m

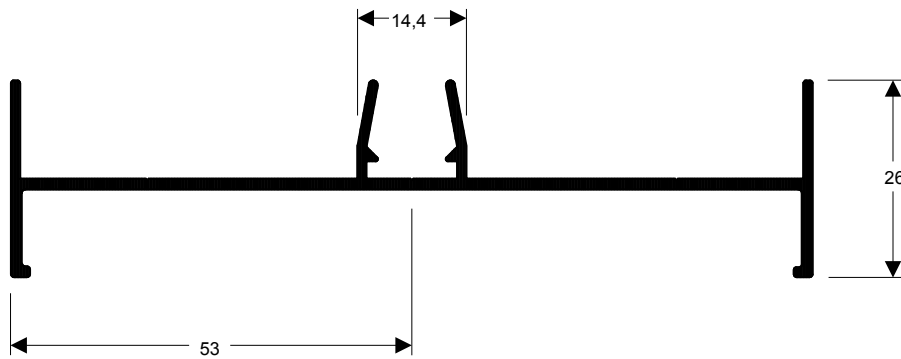

TMS-014
0,647 kg/m

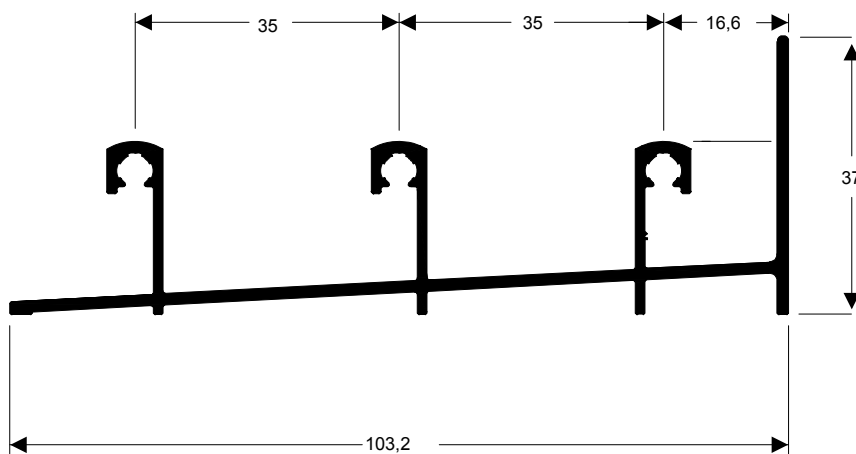

TMS-230
0,940 kg/m

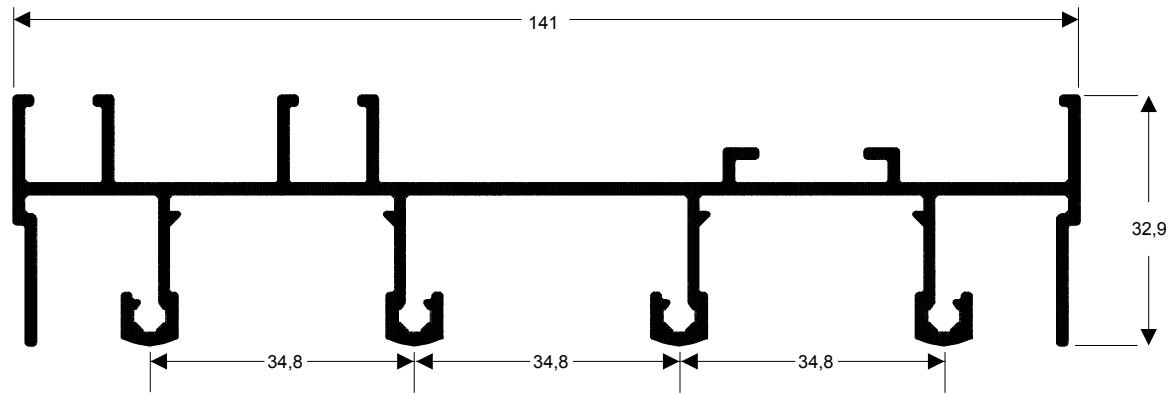

TMS-121
1,449 kg/m

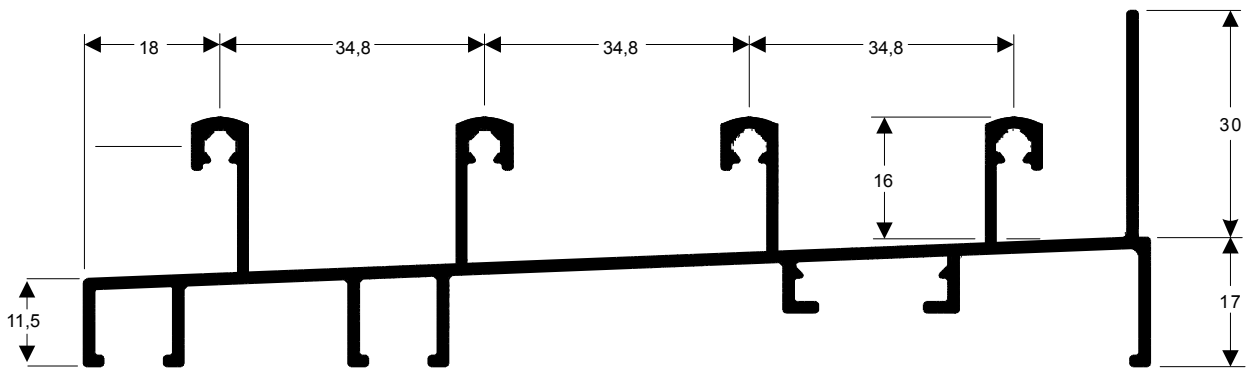

TMS-122
1,401 kg/m

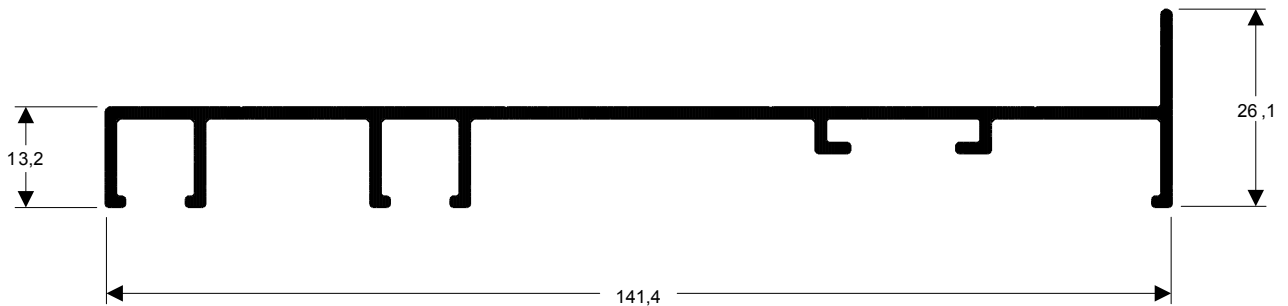

TMS-123
0,970 kg/m

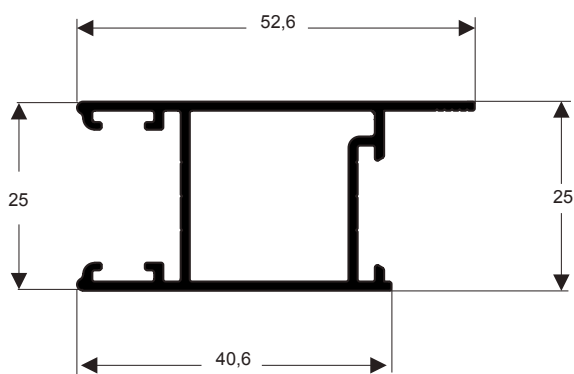

TMS-039
0,488 kg/m

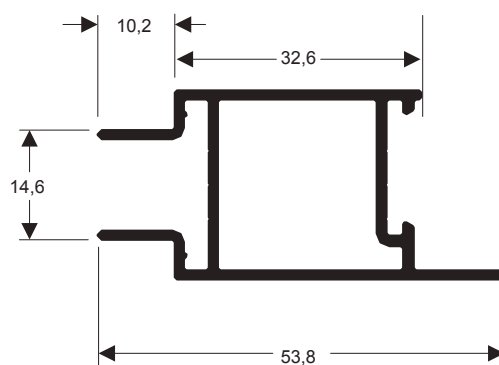

TMS-192
0,517 kg/m

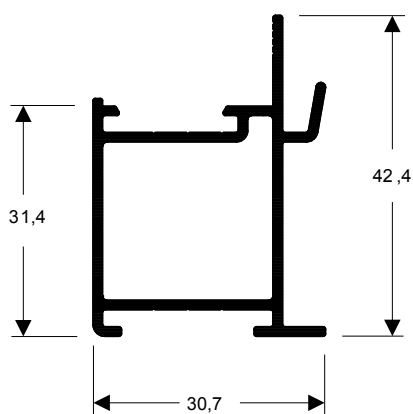

TMS-040
0,476 kg/m

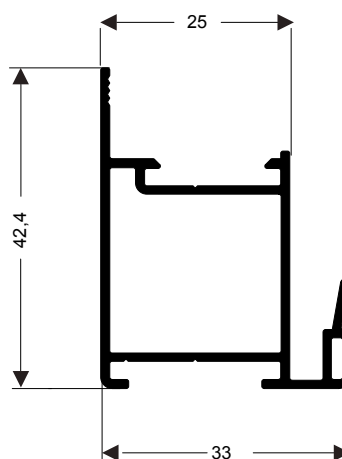

TMS-041
0,485 kg/m

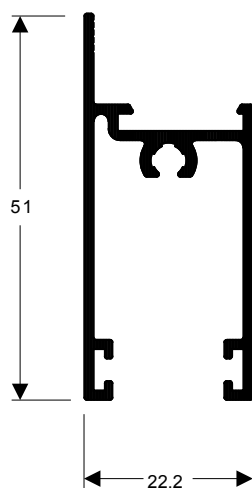

TMS-053
0,471 kg/m

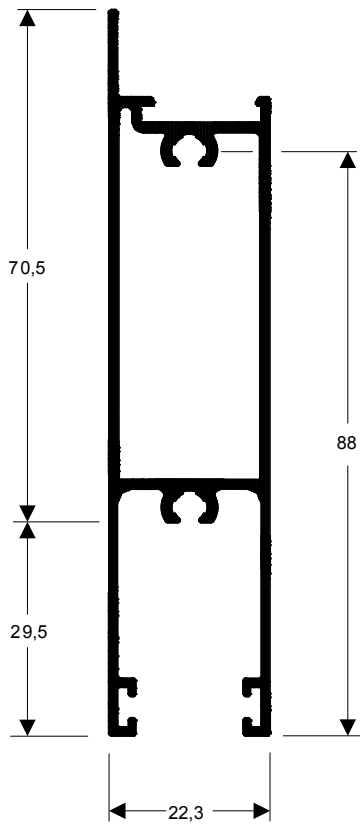

TMS-225
0,997 kg/m

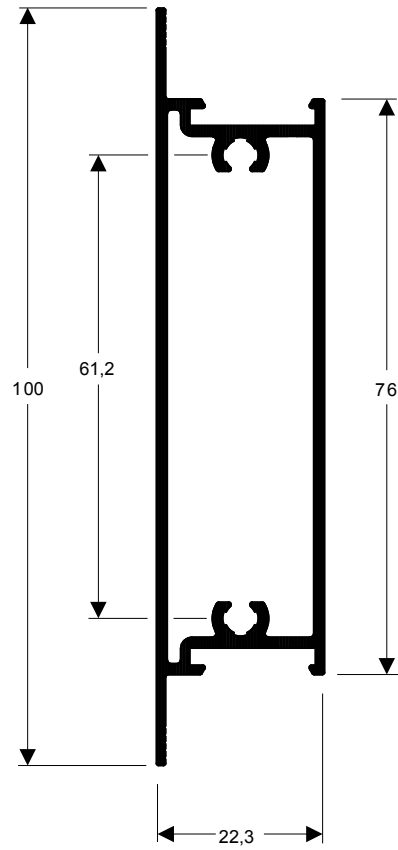

TMS-050
0,930 kg/m

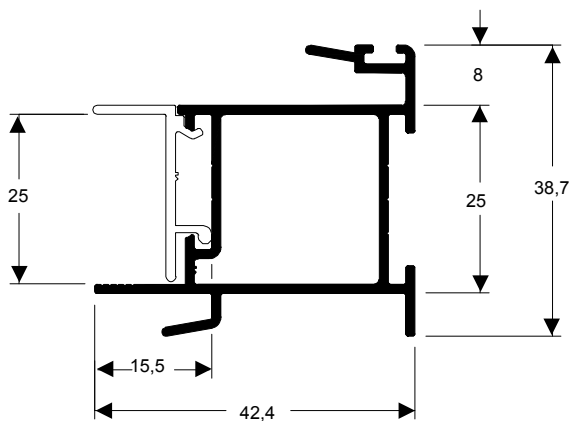

TMS-042
0,561 kg/m

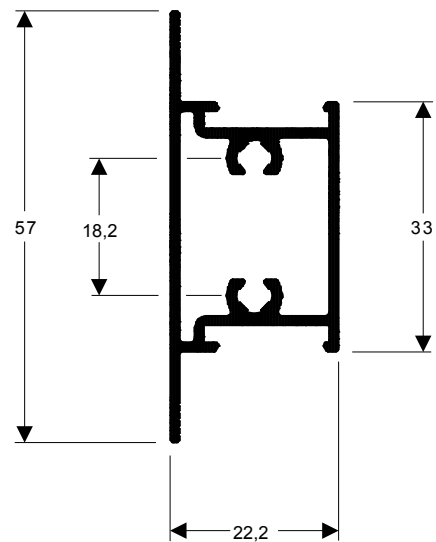

TMS-227
0,556 kg/m

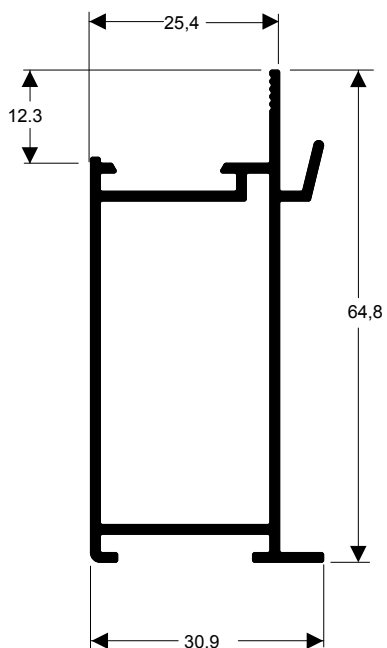

TMS-243
0,710 kg/m

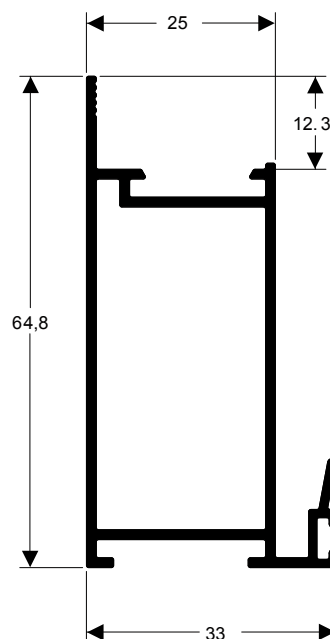

TMS-242
0,710 kg/m

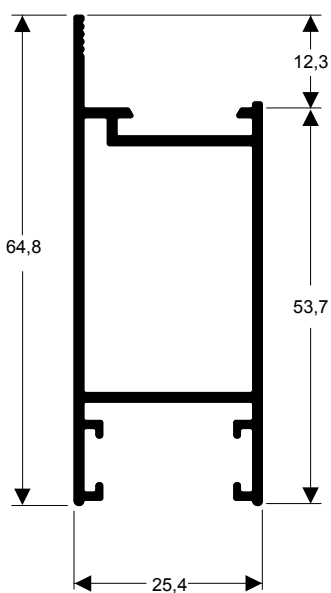

TMS-245
0,672 kg/m

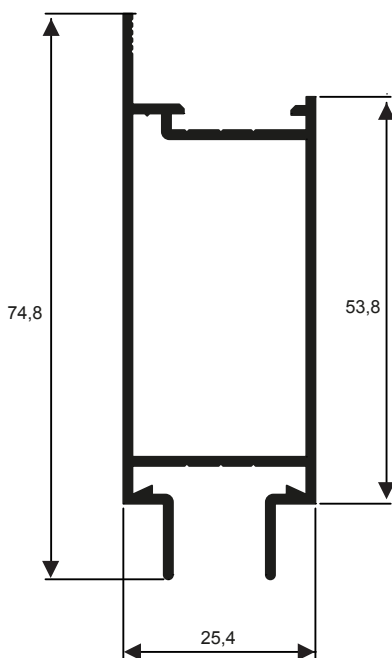

TMS-244
0,661 kg/m

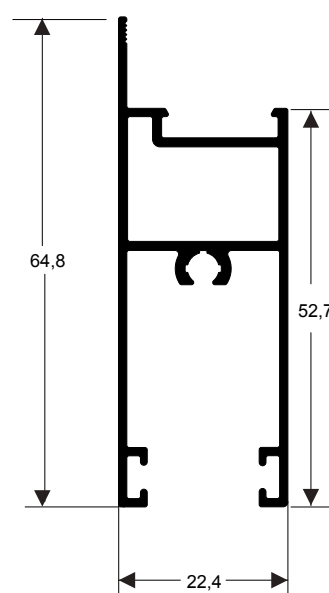

TMS-246
0,593 kg/m

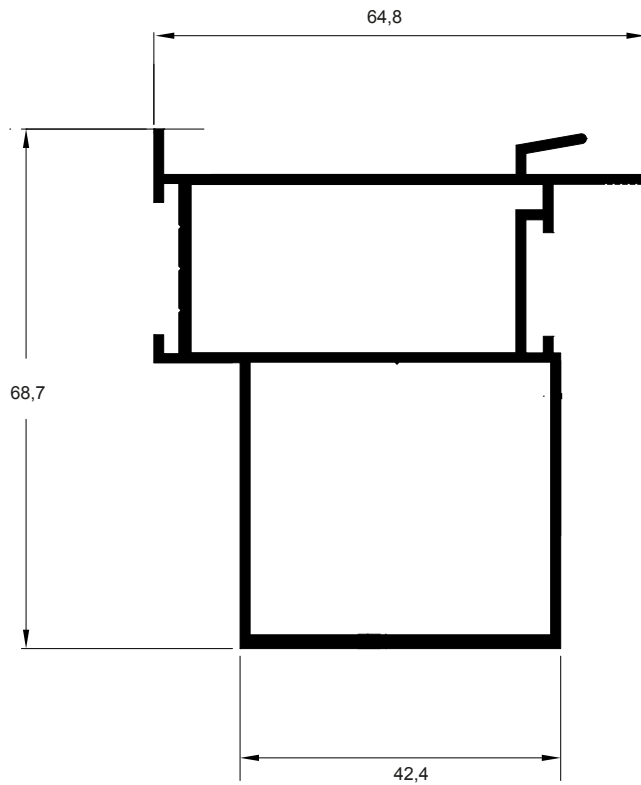

TMS-289

1,225 kg/m

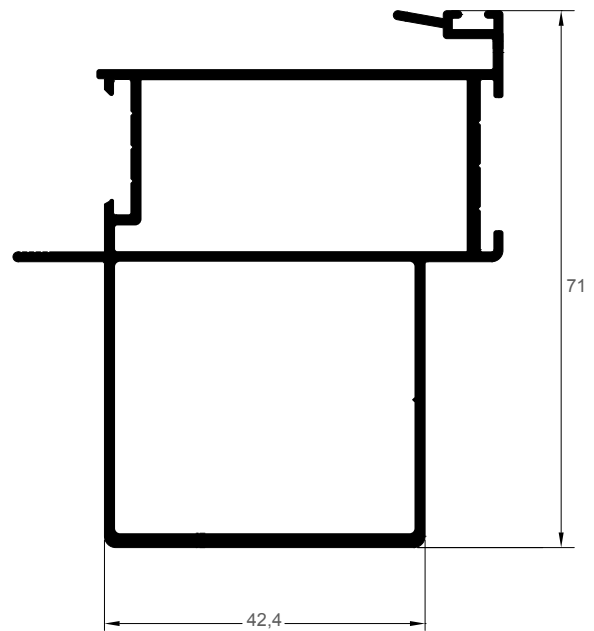

TMS-290

1,255 kg/m

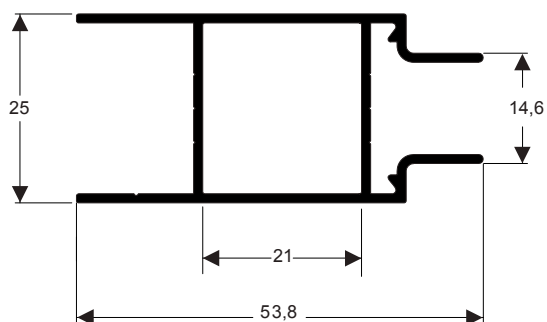

TMS-191
0,542 kg/m

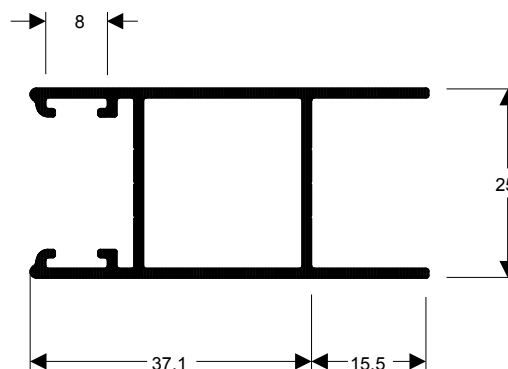

TMS-068
0,495 kg/m

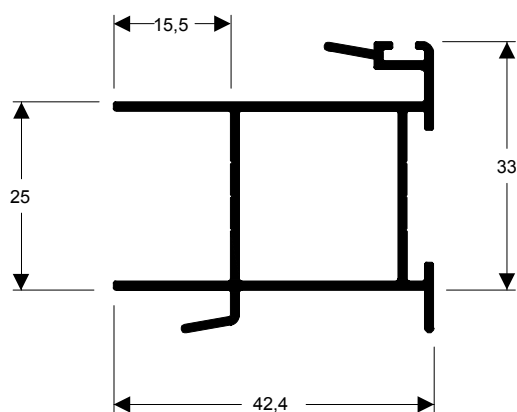

TMS-069
0,577 kg/m

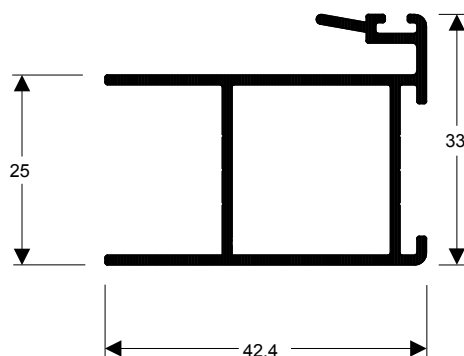

TMS-070
0,517 kg/m

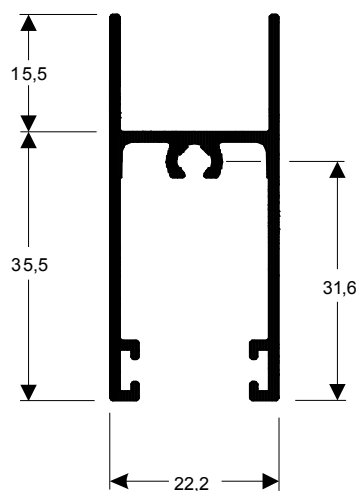

TMS-187
0,509 kg/m

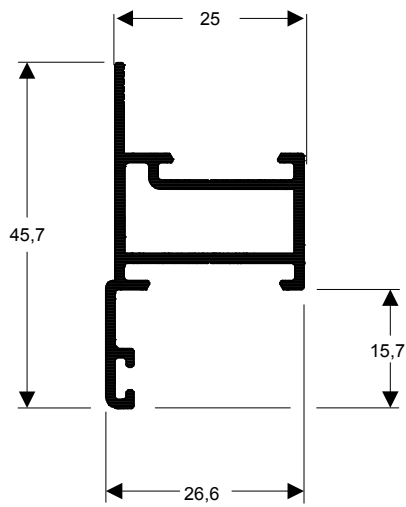

TMS-200

0,442 kg/m

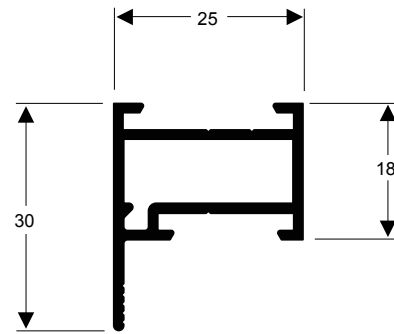

TMS-080

0,360 kg/m

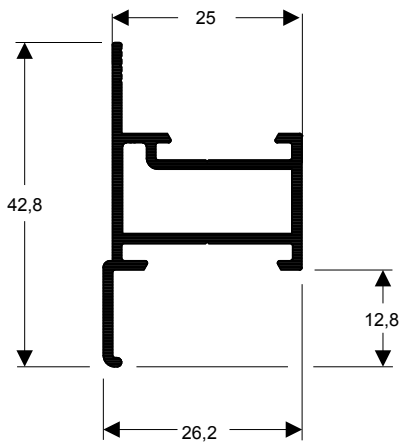

TMS-081

0,404 kg/m

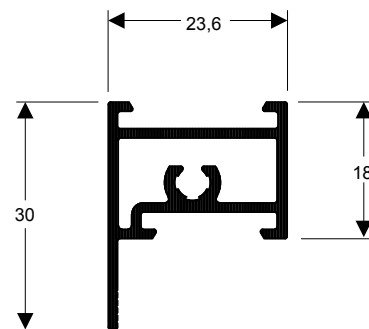

TMS-082

0,382 kg/m

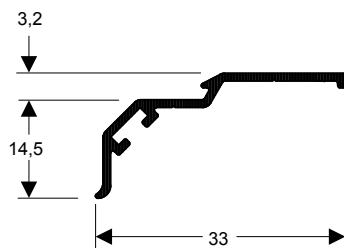

TMS-083

0,146 kg/m

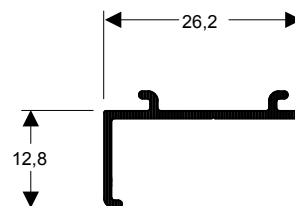

TMS-084

0,114 kg/m

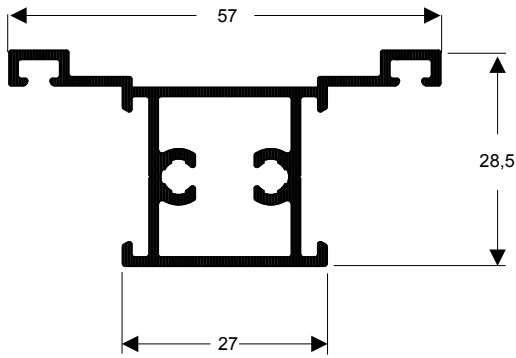

TMS-086

0,596 kg/m

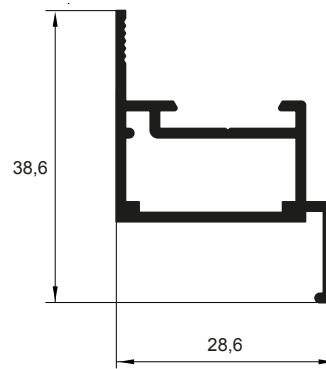

TMS-098

0,404 kg/m

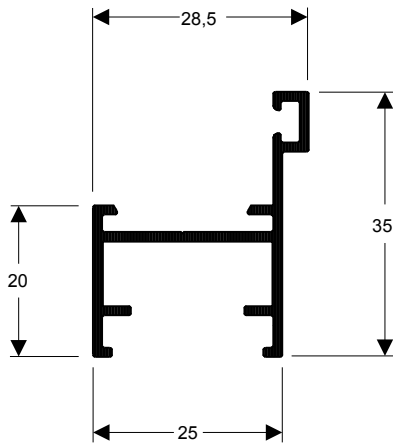

TMS-079

0,333 kg/m

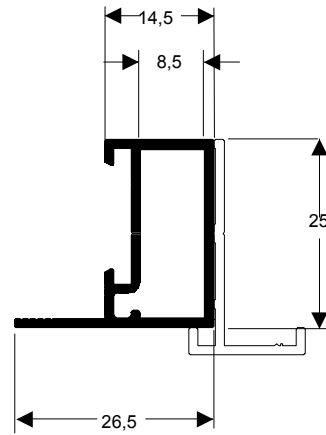

TMS-096

0,306 kg/m

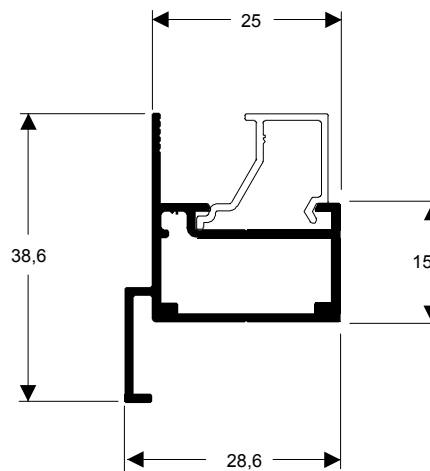

TMS-097

0,404 kg/m

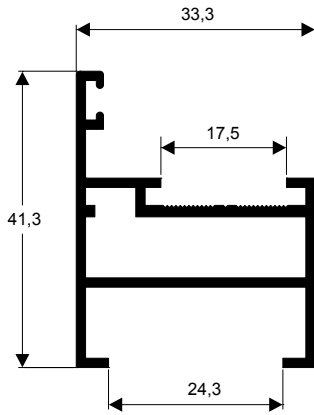

TMS-279
0,552 kg/m

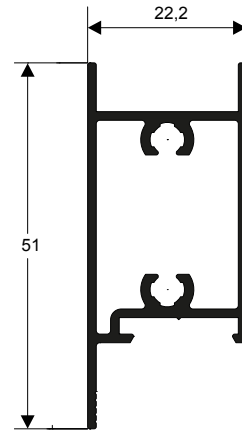

TMS-110
0,534 kg/m

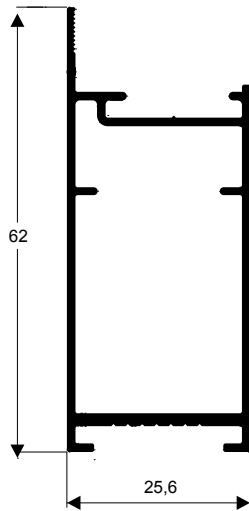

TMS-111
0,615 kg/m

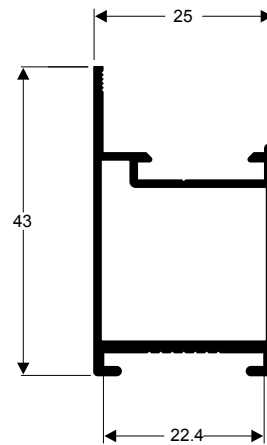

TMS-120
0,466 kg/m

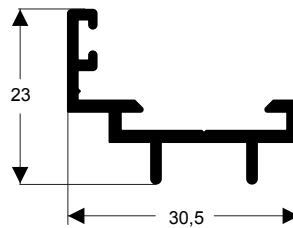

L-715
0,279 kg/m

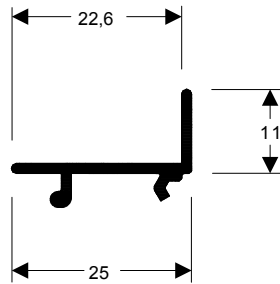

TMS-108
0,142 kg/m

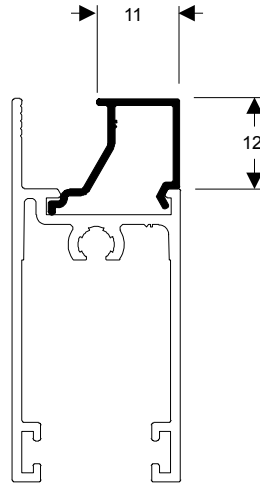

TMS-102
0,111 kg/m

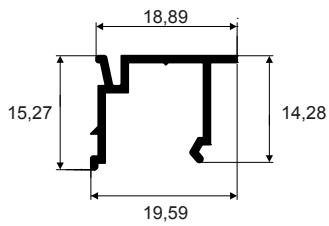

TMS-203
0,130 kg/m

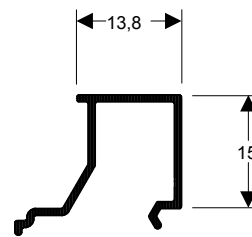

TMS-103
0,141 kg/m

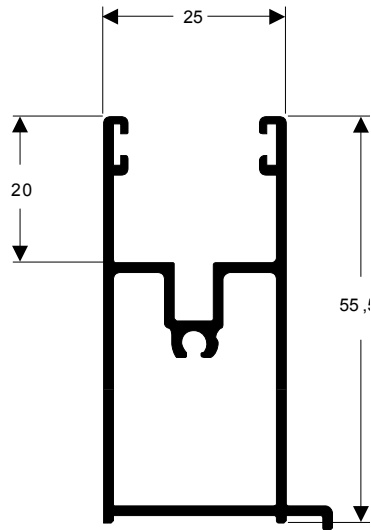

TMN-007
0,715 kg/m

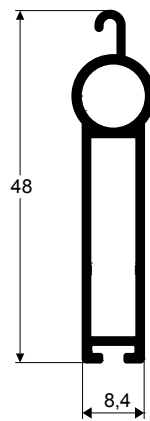

TMN-055
0,380 kg/m

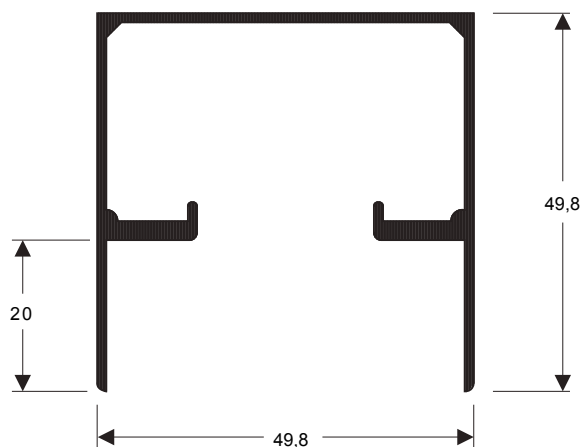

U-397

0,680 kg/m

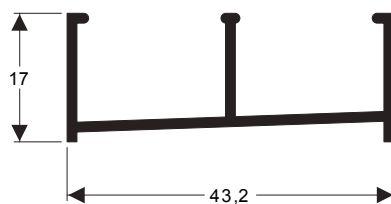

E-117

0,325 kg/m

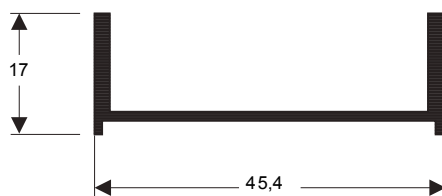

U-399

0,239 kg/m

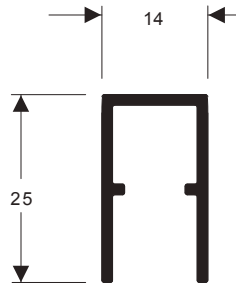

U-396
0,239 kg/m

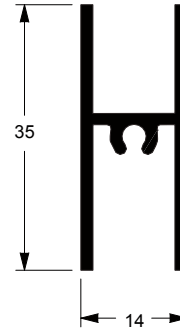

I-083
0,339 kg/m

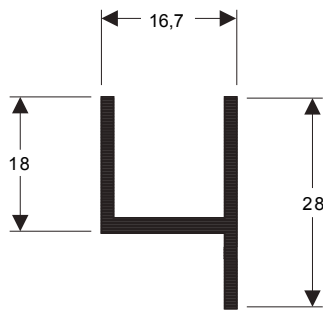

Y-107
0,184 kg/m

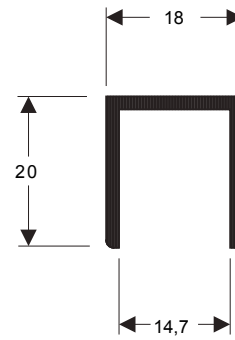

U-398
0,249 kg/m

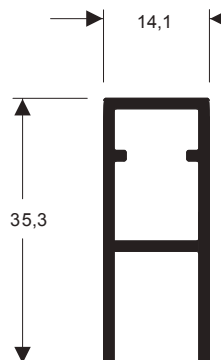

A-022
0,317 kg/m

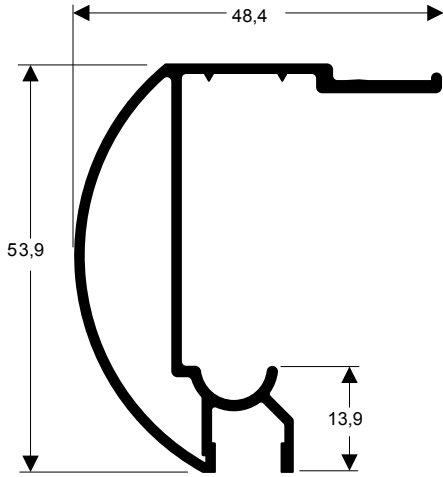

TMR-845
0,585 kg/m

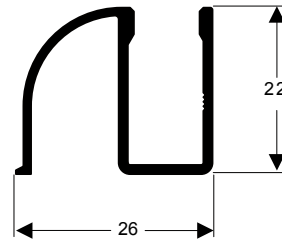

TMB-116
0,263 kg/m

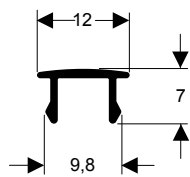

TMR-792
0,057 kg/m

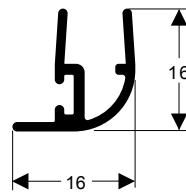

TMR-793
0,141 kg/m

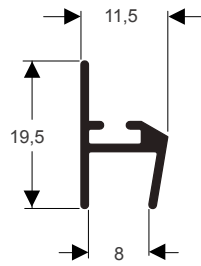

TMB-081A
0,130 kg/m

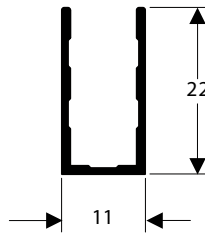

DP-001
0,141 kg/m

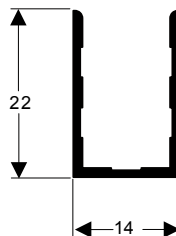

TMR-821
0,162 kg/m

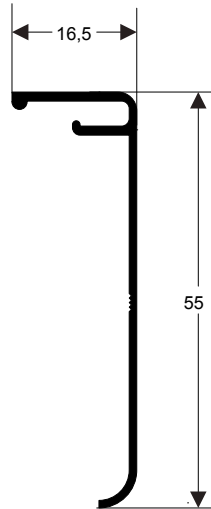

TMB-115
0,233 kg/m

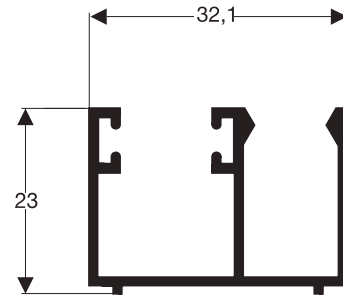

TMR-714
0,328 kg/m

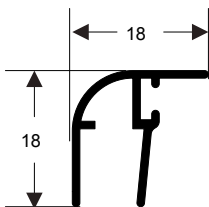

TMB-102
0,152 kg/m

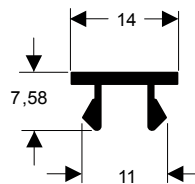

TMR-716
0,084 kg/m

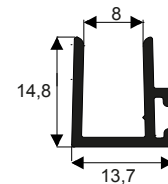

TMR-790
0,157 kg/m

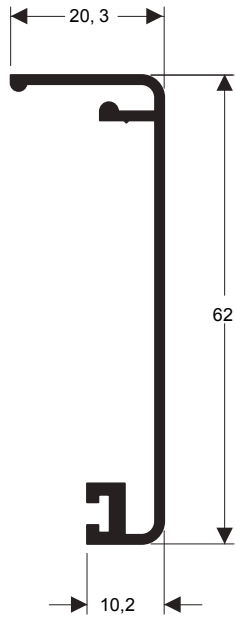

E-512A
0,380 kg/m

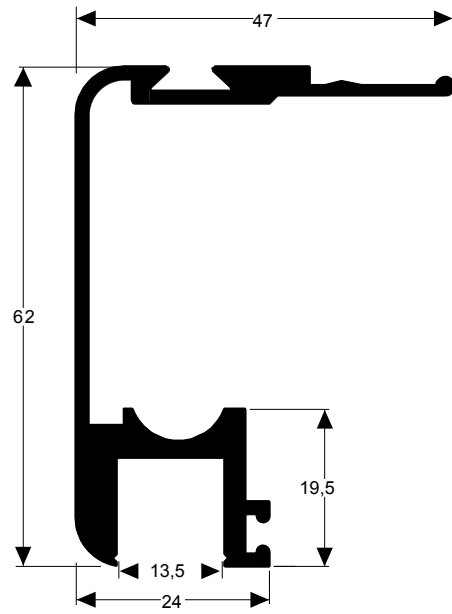

L-713A
0,957 kg/m

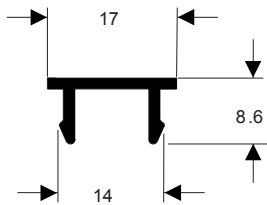

U-491
0,095 kg/m

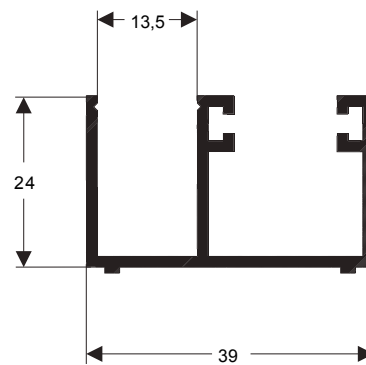

E-306
0,428 kg/m

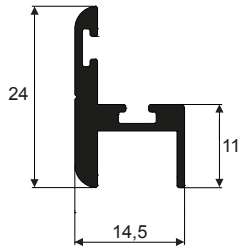

Y-343A
0,263 kg/m

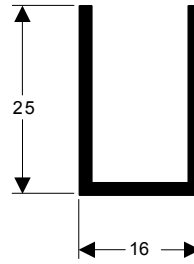

U-555
0,271 kg/m

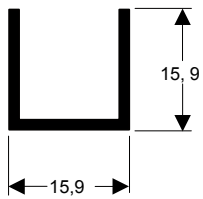

U-509
0,192 kg/m

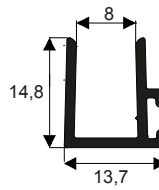

TMR-790
0,157 kg/m

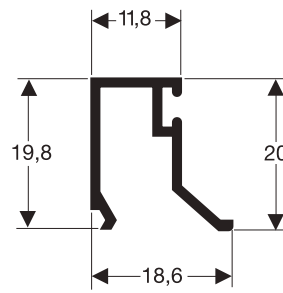

TMR-719

0,163 kg/m

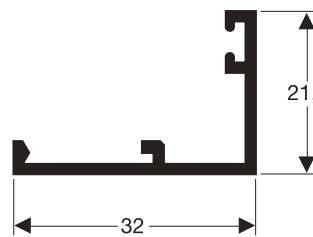

TMR-720

0,235 kg/m

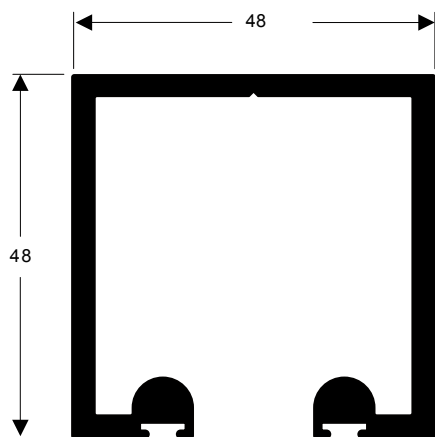

TMR-1035
1,436 kg/m

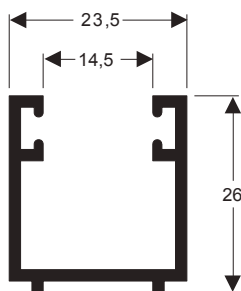

U-1108
0,358 kg/m

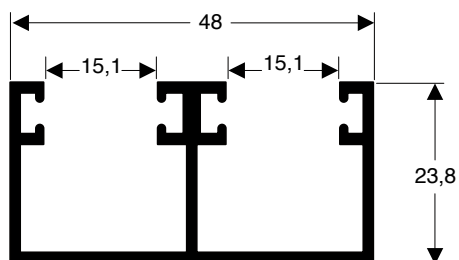

DP-011
0,547 kg/m

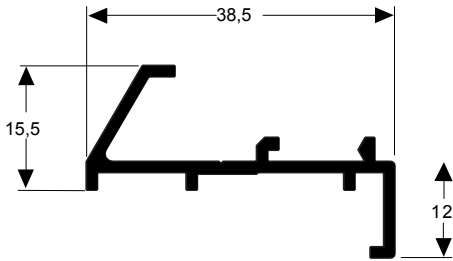

Z-063
0,308 kg/m

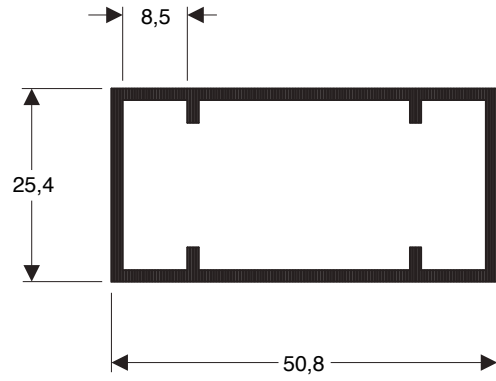

D-079
0,523 kg/m

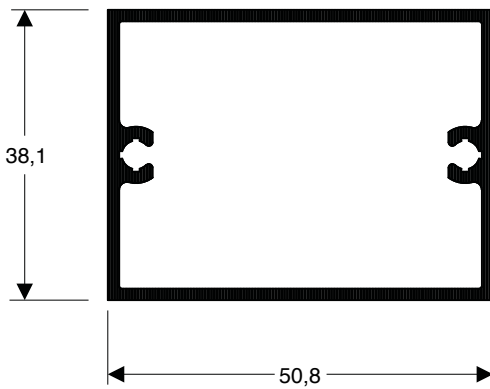

D-103
0,770 kg/m

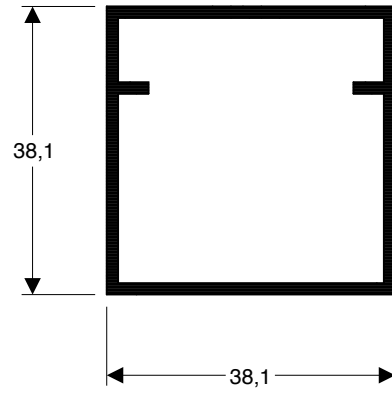

D-102
0,547 kg/m

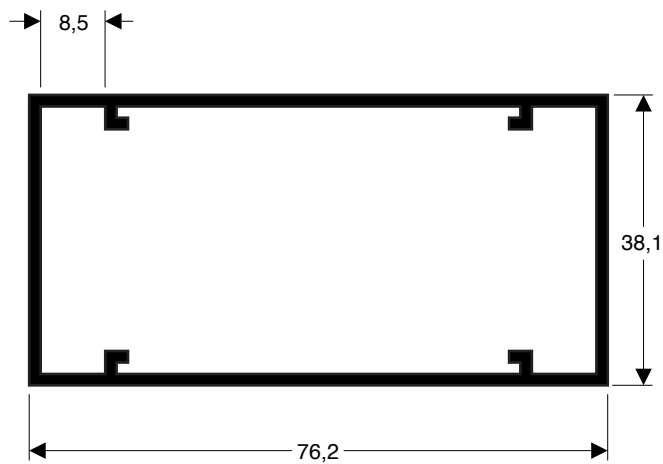

D-069
0,900 kg/m

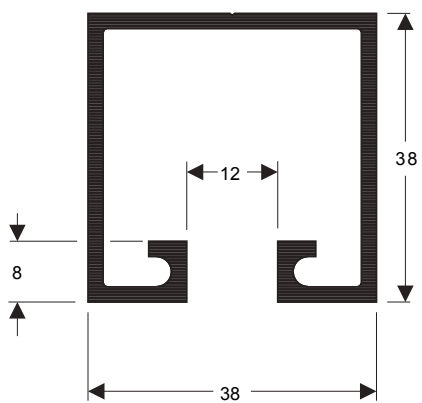

U-990
0,750 kg/m

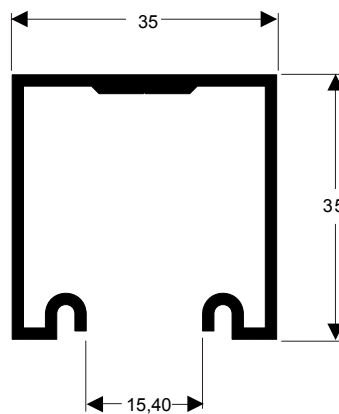

U-1098
0,569 kg/m

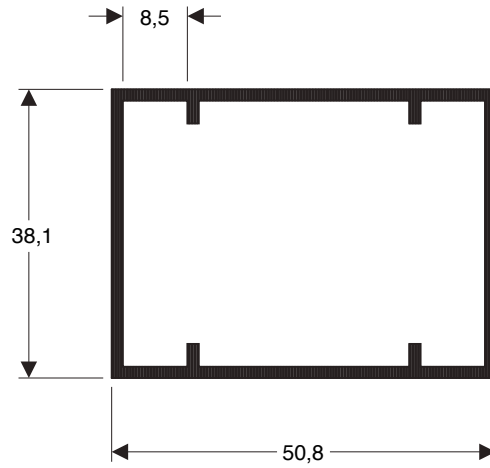

D-078

0,653 kg/m

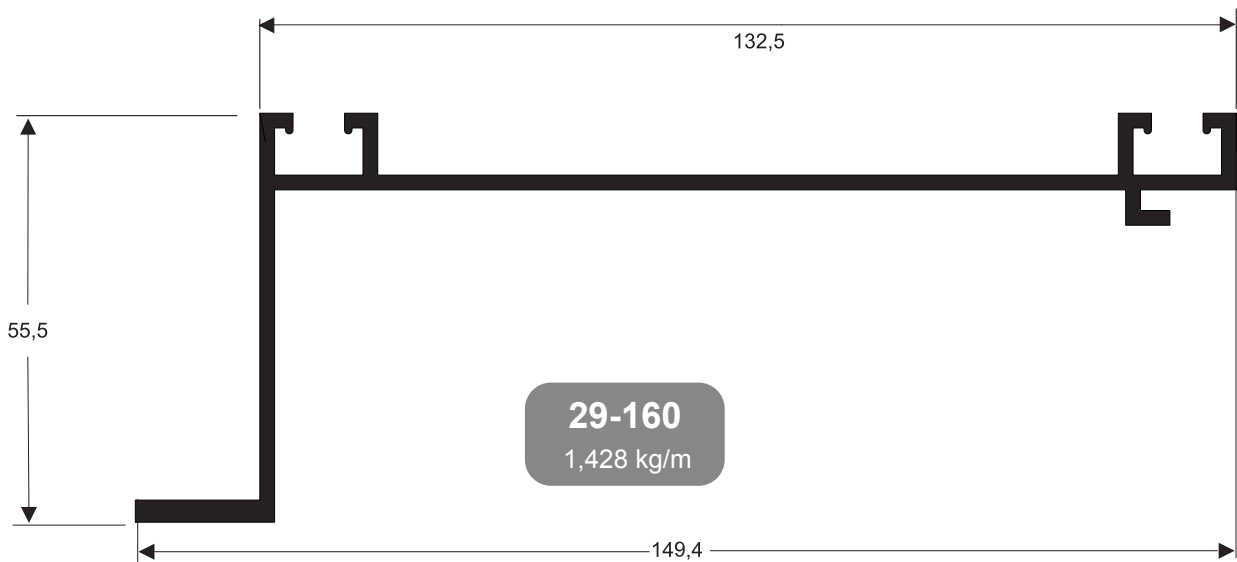

29-160

1,428 kg/m

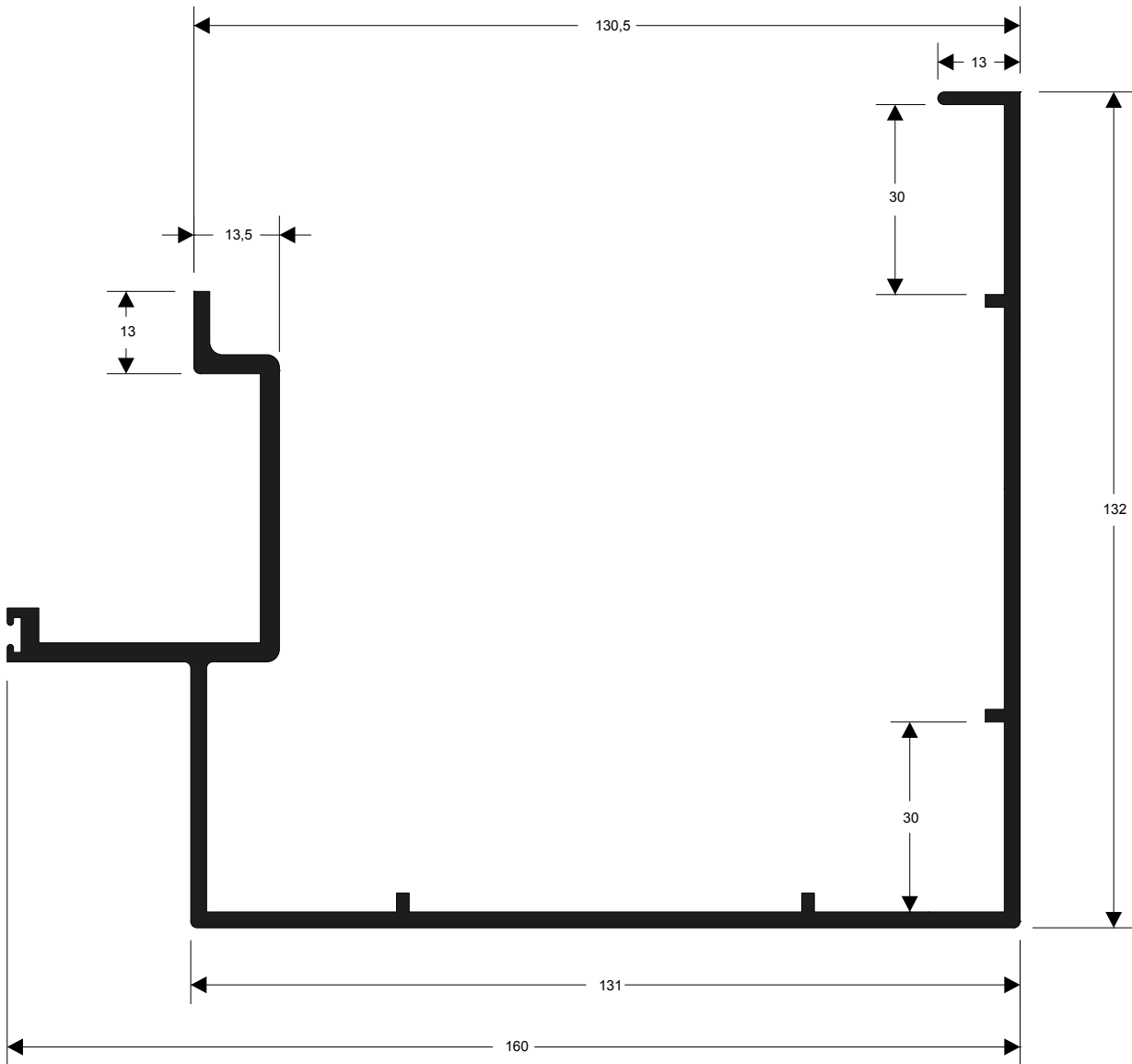

39-811

3,070 kg/m

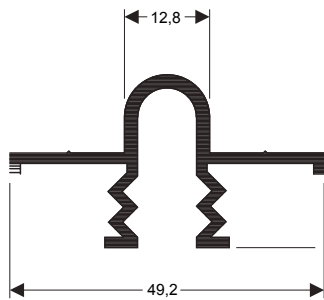

E-364

0,472 kg/m

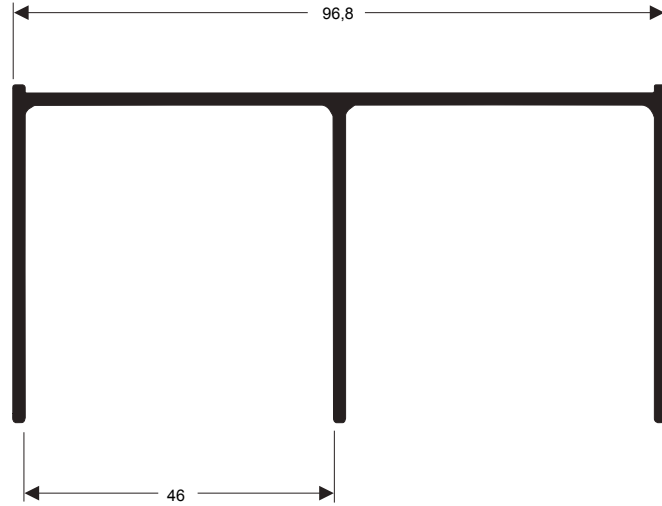

E-363

1,051 kg/m

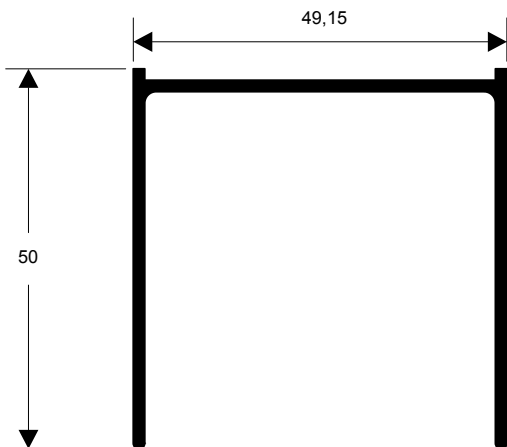

M-027

0,596 kg/m

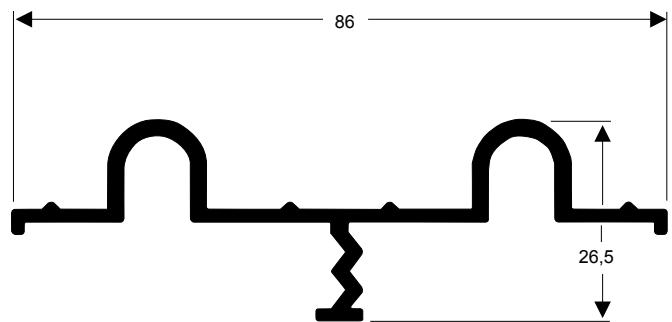

E-365

0,653 kg/m

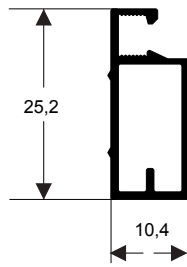

TMR-1190
0,190 kg/m

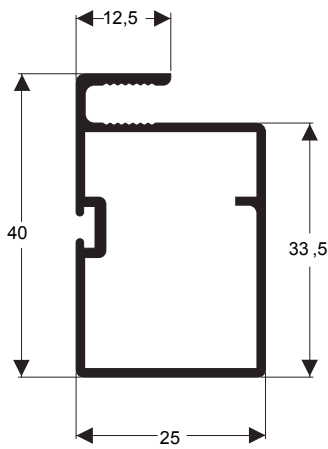

P-227
0,463 kg/m

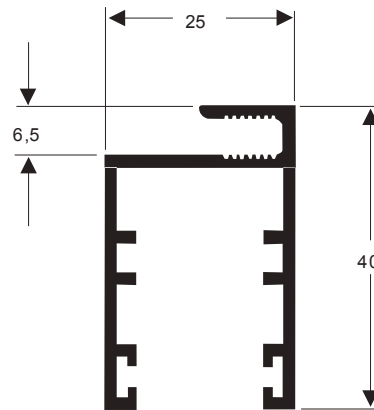

Y-312
0,512 g/m

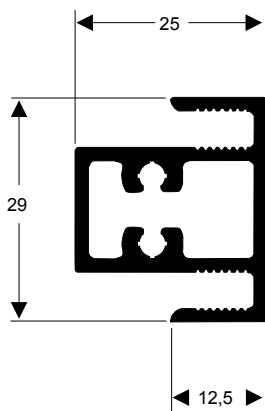

P-256
0,520 kg/m

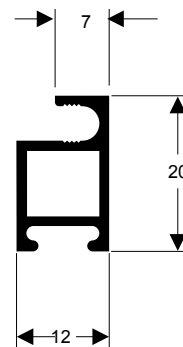

A-058
0,201 kg/m

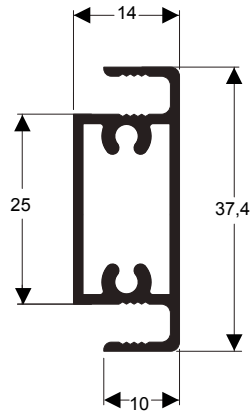

TMR-743
0,405 kg/m

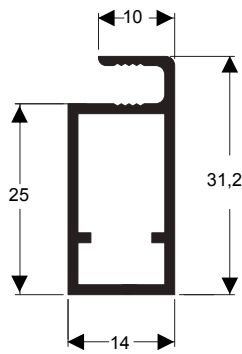

TMR-742
0,315 kg/m

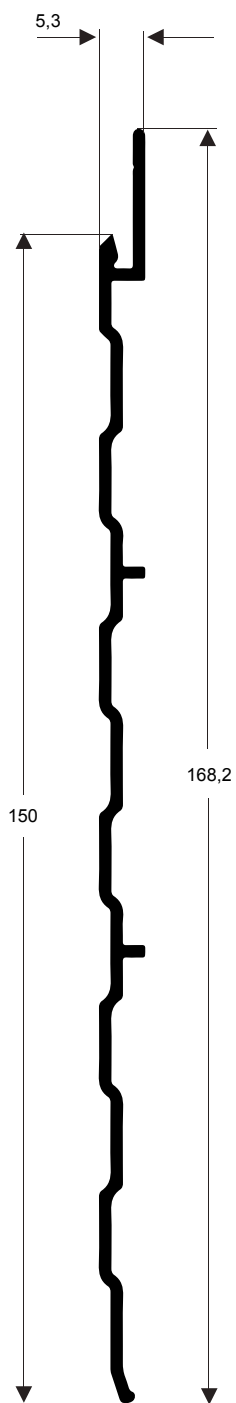

Y-429
0,632 kg/m

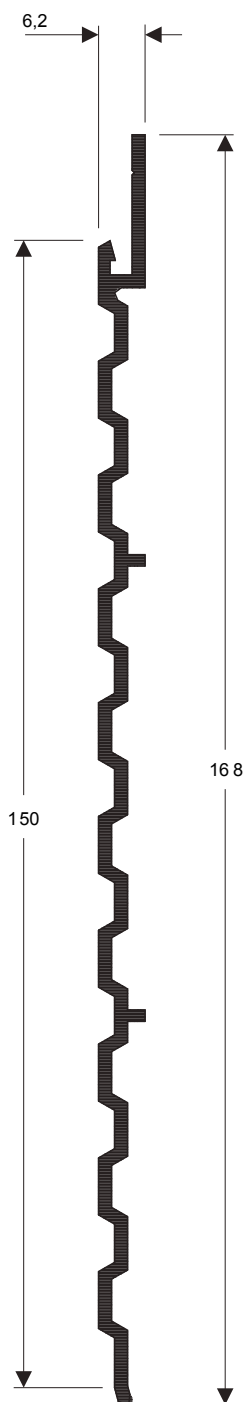

Y-355
0,688 kg/m

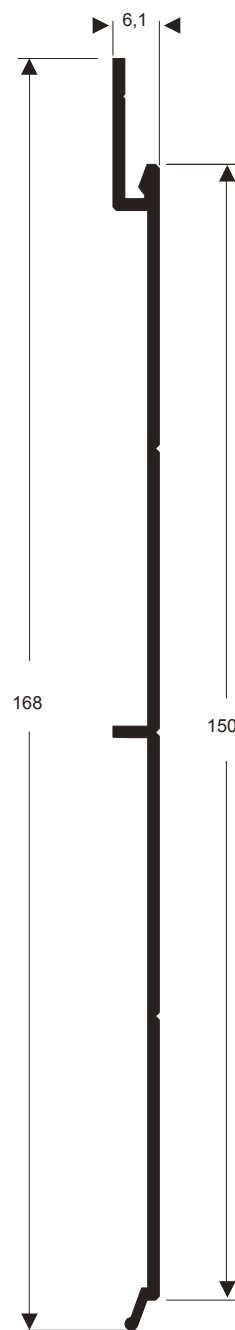

Y-335
0,756 kg/m

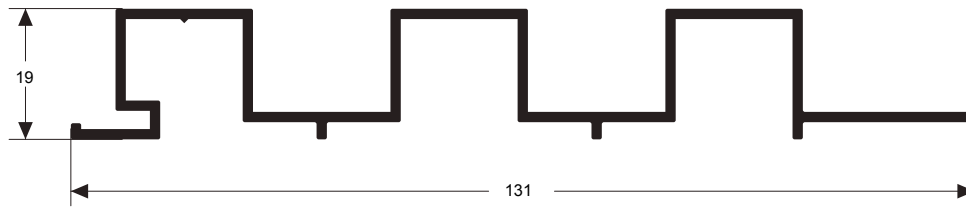

TMR-3093

0,984 kg/m

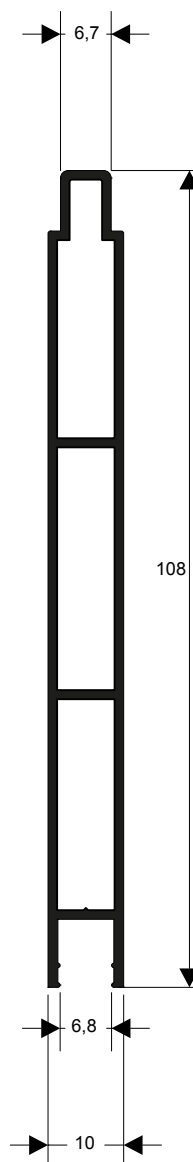

TMR-1381

0,807 kg/m

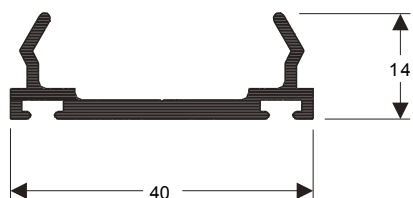

U-615
0,368 kg/m

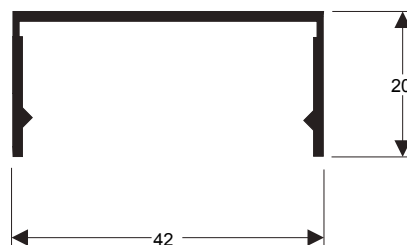

U-621
0,265 kg/m

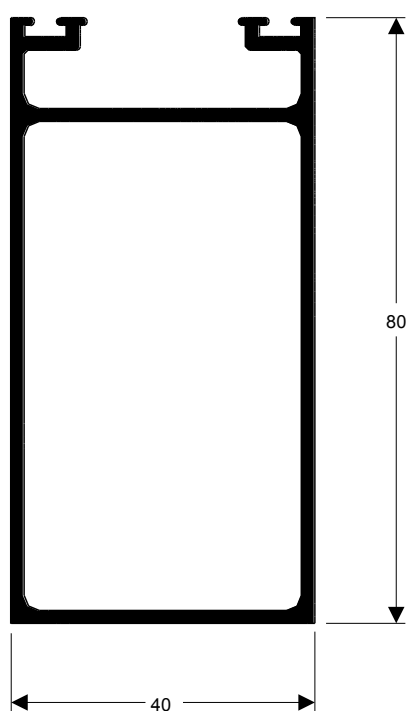

A-072
1,203 kg/m

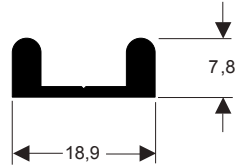

TMR-837
0,195 kg/m

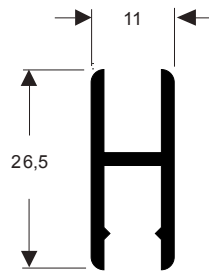

TMR-835
0,320 kg/m

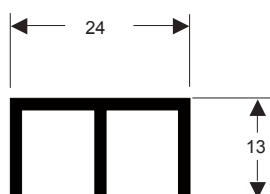

E-168

0,222 kg/m

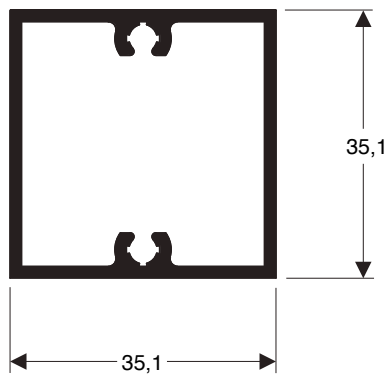

D-081

0,572 kg/m

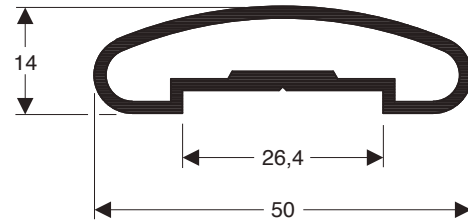

D-095

0,413 kg/m

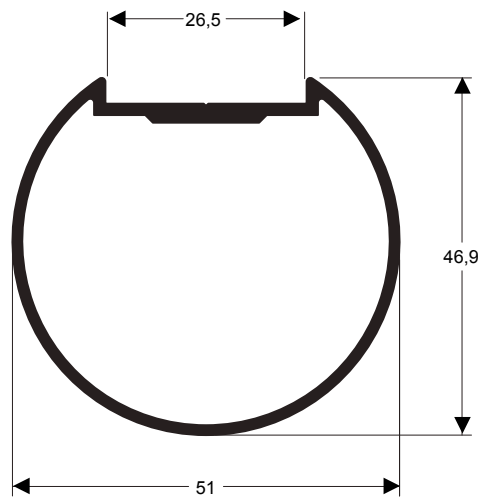

TMB-096

0,626 kg/m

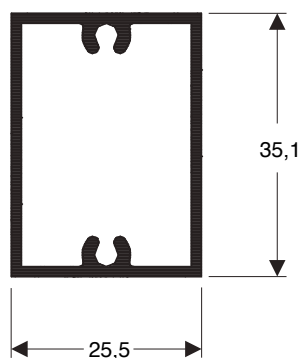

D-055
0,504 kg/m

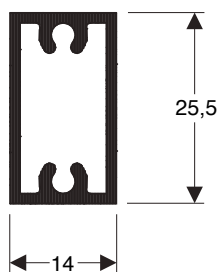

D-082
0,320 kg/m

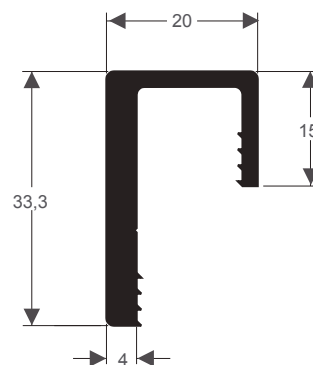

TMR-626
(CG-075)
0,520 kg/m

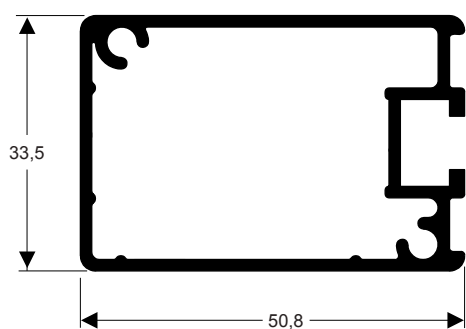

TMR-624
(CG-077)
0,840 kg/m

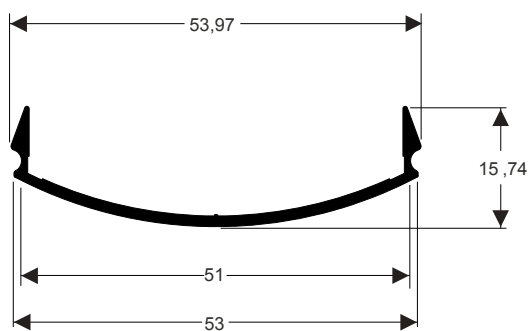

TMR-625
(CG-074)
0,282 kg/m

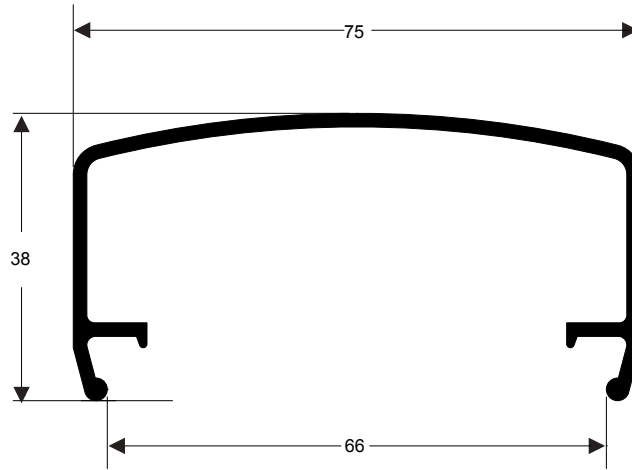

39-081
0,772 kg/m

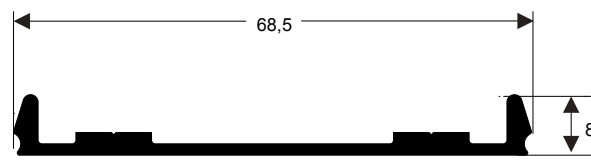

U-1092
0,442 kg/m

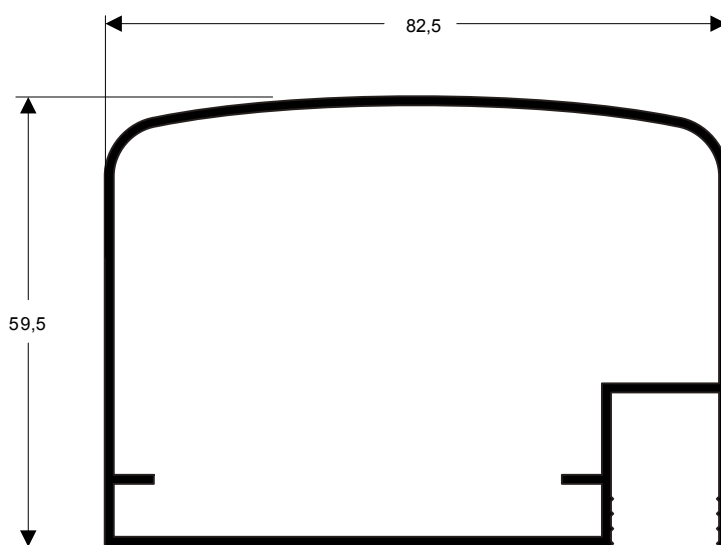

78-054

1,051 kg/m

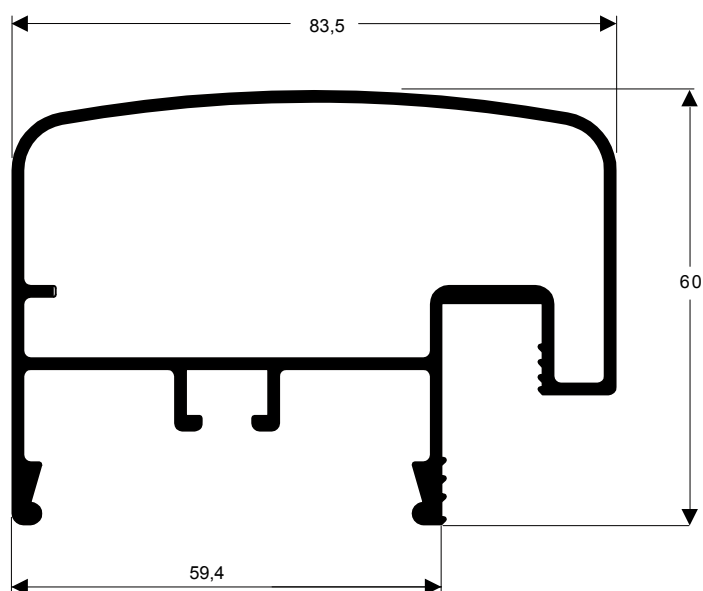

CG-083

1,410 kg/m

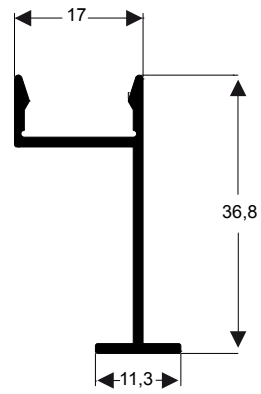

TMR-1447
0,252 kg/m



cledial
ALUMÍNIO



(11) 3608-4949
Ramal: 2637 | 0878



vendas@cledial.com.br



**Av. dos Automistas, 6794 Vila
Quitaúna, SP - CEP: 06194-060**



CLEDIAL.COM.BR